



Kenya Power

TITLE:

**SPECIFICATION FOR LOW
VOLTAGE MEASURING
INSTRUMENTS**

Part 3: Multimeters

72

Doc. No. KP1/3CB/TSP/09/058-3

Issue No. 1

Revision No. 0

Date of Issue 2014-07-06

Page 1 of 24

TABLE OF CONTENTS

0.1 Circulation List

0.2 Amendment Record

FOREWORD

1. SCOPE
2. REFERENCES
3. TERMS AND DEFINITIONS
4. REQUIREMENTS
5. TESTS AND INSPECTION
6. MARKING AND PACKING
7. DOCUMENTATION

ANNEX A: *Guaranteed Technical Particulars (to be filled and signed by the Manufacturer and submitted together with relevant copies of the Manufacturer's catalogues, brochures, drawings, technical data, sales records for previous five years, four customer reference letters, details of manufacturing capacity, the manufacturer's experience and copies of complete type test certificates and type test reports for tender evaluation, all in English Language)*

Issued by: Head of Section, Technical Standards & Specifications

Signed:

Date: 2014-07-06

Authorized by: Head of Department, Research & Development

Signed:

Date: 2014-07-06



Kenya Power

TITLE:

SPECIFICATION FOR LOW VOLTAGE MEASURING INSTRUMENTS

Part 3: Multimeters

Doc. No.

KP1/3CB/TSP/09/058-3

Issue No.

1

Revision No.

0

Date of Issue

2014-07-06

Page 2 of 24

0.1 Circulation List

COPY NO.	COPY HOLDER
1	Research & Development Manager
2	Supply Chain Manager (Procurement)
Electronic copy (pdf) on Kenya Power server (http://172.16.1.40/dms/browse.php?ffolderId=23)	

0.2 Amendment Record

Rev No.	Date (YYYY-MM-DD)	Description of Change	Prepared by (Name & Signature)	Approved by (Name & Signature)
0	2014-07-06	New Issue	Michael Apudo 	Eng. Simon Kimitei

Issued by: Head of Section, Technical Standards & Specifications

Signed:

Date: 2014-07-06

Authorized by: Head of Department, Research & Development

Signed:

Date: 2014-07-06



Kenya Power

TITLE:

SPECIFICATION FOR LOW VOLTAGE MEASURING INSTRUMENTS

Part 3: Multimeters

Doc. No. KP1/3CB/TSP/09/058-3

Issue No. 1

Revision No. 0

Date of Issue 2014-07-06

Page 3 of 24

FOREWORD

This specification has been prepared by the Research and Development Department in collaboration with Distribution Division, both of The Kenya Power and Lighting Company Limited (KPLC) and it lays down requirements for overhead line instruments (Multimeters) for use on distribution power lines. It is intended for use by KPLC in purchasing of the instrument.

1. SCOPE

- 1.1 This specification is for low voltage measuring instruments for use on overhead distribution power lines.
- 1.2 The specification covers the following categories of low voltage (600 -1000 V) overhead line measurement instruments:
 - a) Digital Multimeter Test Set
 - b) Digital Clamp-On Multimeter

Note: The sizes shall be as per the schedule of requirements in the tender.

- 1.3 The specification also covers inspection and tests of the multimeters and their accessories as well as schedule of Guaranteed Technical Particulars to be filled, signed by the manufacturer and submitted for tender evaluation.
- 1.4 The specification stipulates the minimum requirements for low voltage multimeters for overhead power lines acceptable for use in the company and it shall be the responsibility of the suppliers & manufacturer to ensure adequacy of the design, good workmanship and good engineering practice in the manufacture of the multimeters for KPLC.

The specification does not purport to include all the necessary provisions of a contract.

2. REFERENCES

The following standards contain provisions which, through reference in this text constitute provisions of this specification. Unless otherwise stated, the latest editions (including amendments) apply:

IEC 61010: Safety requirements for electrical equipment for measurement, control, and laboratory use – Part 1: General requirements; –Part 2-033: Particular requirements for hand-held multimeters and other meters, for domestic and professional use, capable of measuring mains voltage,

Issued by Head of Section, Technical Standards & Specifications

Signed:

Date: 2014-07-06

Authorized by: Head of Department, Research & Development

Signed:

Date: 2014-07-06



Kenya Power

TITLE:

SPECIFICATION FOR LOW VOLTAGE MEASURING INSTRUMENTS

Part 3: Multimeters

Doc. No.	KP1/3CB/TSP/09/058-3
Issue No.	1
Revision No.	0
Date of Issue	2014-07-06
Page 4 of 24	

IEC 61557: Electrical safety in low voltage distribution systems up to 1 000 V a.c. and 1 500 V d.c - Equipment for testing, measuring or monitoring of protective measures – Part 1: General requirements; – Part 2: Insulation resistance; – Part 3: Loop impedance; Part 4: Resistance of earth connection and equipotential bonding; -- Part 5: Resistance to earth; --Part 6: Effectiveness of residual current devices (RCD) in TT, TN and IT systems -- Part 7: Phase sequence; – Part 10: Combined measuring equipment for testing, measuring or monitoring of protective measures

IEC 61326: Electrical equipment for measurement, control and laboratory use - EMC requirements.

IEC 60086-2: Primary batteries - Part 2: Physical and electrical specifications

IEC 60529: Degrees of protection provided by enclosures (IP Code)

OIML D 11: General Requirements for Measuring Instruments - Environmental Conditions

3. TERMS AND DEFINITIONS

For the purpose of this specification the definitions given in the reference standards shall apply.

4. REQUIREMENTS

4.1. SERVICE CONDITIONS

The equipment shall be tropicalized, designed and constructed for continuous outdoor operation in tropical areas and harsh climatic conditions including areas exposed to sea spray (along the coast), humidity of up to 95% and average ambient temperature of +30°C with a minimum of -1°C and a maximum of +40°C.

4.2. Design and construction

4.2.1. Measuring instruments shall comply with IEC 61010-1 and IEC 61557-1 standards. When used for a designated purpose, they shall not endanger persons, livestock or property i.e. they shall be constructed in such a way that possibilities for unintentional, accidental, or intentional misuse are minimal.

Issued by: Head of Section, Technical Standards & Specifications

Signed:

Date: 2014-07-06

Authorized by: Head of Department, Research & Development

Signed:

Date: 2014-07-06



Kenya Power

TITLE:

SPECIFICATION FOR LOW VOLTAGE MEASURING INSTRUMENTS

Part 3: Multimeters

Doc. No.

KP1/3CB/TSP/09/058-3

Issue No.

1

Revision No.

0

Date of Issue

2014-07-06

Page 5 of 24

4.2.2. The design shall also ensure that no hazardous touch voltages appear during the measurements. This shall be achieved by a suitable design of the source for the output voltage by:

- a) Limiting the open-circuit value of the output voltage to an r.m.s. value of 50 V;
- b) Limiting the r.m.s. (peak) value of the short-circuit current to 3.5 mA when the value of the voltage exceeds 50 V.

NOTE: When no compliance with the above condition exists, then an automatic disconnection of the measurement process shall operate within a time period permissible according to Figure 1 of IEC 61010-1.

4.2.3. If the measuring equipment indicates the voltage conditions at its measuring terminals, it shall also indicate if the system voltage exists and if the live conductor is exchanged with the protective conductor.

4.2.4. Measuring instruments shall also comply with OIML D 11 requirements such that:

- a) Their errors do not exceed the maximum permissible errors under rated operating conditions.
- b) When they are exposed to disturbances, either
 - Significant faults do not occur, or
 - Significant faults are detected and acted upon by means of a checking facility.

4.2.5. Instruments powered by a battery (stand-alone, rechargeable auxiliary or back-up batteries) shall have the type (-s) and capacity (-ies) of the batteries allowed to be used in the applicable measuring instruments specified by the manufacturer. They shall also automatically check that the state of charge of these batteries will permit measurement with specification.

4.2.6. Instruments powered by the mains power and provided with a back-up battery for data-storage only, shall also comply with the requirements for mains powered instruments.

4.2.7. The terminals shall be designed so that the probe assembly can be connected to the measuring equipment reliably and accidental touching of any live parts is impossible.

4.2.8. Software controlled instruments that are complex in their functionality shall require that the user is guided for the correct use and for achieving correct measurement results.

4.2.9. The manufacturer shall specify the limiting conditions; storage and transport conditions for each specified influence quantity - quantity which is not the subject of the measurement and whose change affects the relationship between the indication and the result of the measurement.

Issued by: Head of Section, Technical Standards & Specifications

Signed:

Date: 2014-07-06

Authorized by: Head of Department, Research & Development

Signed:

Date: 2014-07-06



Kenya Power

TITLE:

SPECIFICATION FOR LOW VOLTAGE MEASURING INSTRUMENTS

Part 3: Multimeters

Doc. No. KP1/3CB/TSP/09/058-3

Issue No. 1

Revision No. 0

Date of Issue 2014-07-06

Page 6 of 24

4.2.10. Measuring equipment shall have a valid calibration status prior to being confirmed, within a specified metrological requirement.

4.2.11. The measuring instruments shall be manufactured and tested in conformity with the following safety and environmental design requirements:

Table 1: Safety and Environmental Design Requirements

No	Particulars	Test Performance	
1	Operating conditions	Operating temperature	0 ... +35 °C as per IEC 61557-1
		Storage temperature	-5 ... +50 °C
		Humidity range - Rel. humidity	5 ... 95 %, non-condensing
		Permissible percentage operating uncertainties	Shall not exceed ±30 % as per IEC 61557-1
		Supply voltage	85 % to 110 % of the nominal supply voltage for supply from the distribution systems as per IEC 60038
2	Environmental conditions	Shock (operating)	15 g / 11 ms half sine as per IEC 60068-2-27
		Vibration (operating)	IEC 61557-1 - direction: three mutually perpendicular axes; - amplitude: 1 mm; - frequency: 25 Hz; - duration: 20 min.
		Dry heat test	IEC 60068-2-2: Type A test (Test level 2) Temperature - 55°C ± 2°C Duration of exposure - 2 h
		Damp heat test	IEC 60068-2-30: Test Db Test level 2 Temperature - 55°C ± 2°C Relative humidity - 93 % Duration of exposure - 4 h
		Salt mist test	IEC 60068-2-11 - Test level 4 Saline solution - 5 % NaCl, pH value- 6.5 - 7.2 %, Temperature - 35°C Duration - 96 h
		Flammability test	IEC 60695-2-11 - Needle flame test
2	EMC tests*	Particular requirements test configurations, operational conditions and performance criteria	IEC 61326-2-2.
		Rated Impulse Voltage for equipment - 1.2/50µs	6000 V as per IEC 60664-1, table 1
		Overvoltage category	Category IV, 600 V or III, 1000V as per IEC 61010-1

Issued by: Head of Section, Technical Standards & Specifications

Signed:

Date: 2014-07-06

Authorized by: Head of Department, Research & Development

Signed:

Date: 2014-07-06



Kenya Power

TITLE:

SPECIFICATION FOR LOW VOLTAGE MEASURING INSTRUMENTS

Part 3: Multimeters

Doc. No. KP1/3CB/TSP/09/058-3

Issue No. 1

Revision No. 0

Date of Issue 2014-07-06

Page 7 of 24

No	Particulars	Test Performance	
3	Safety	Pollution category	At least Degree 2 as per IEC 61010-1
		Insulation material group	At least Group II - $400 \leq CTI < 600$ (PLC=1) as per IEC 60112
		Class of protection	Protection class II (reinforced insulation) as per 60664-1
		Protection against enclosures	IP 54 as per IEC 60529
		Measuring category	At least category III as per IEC 61010-2-030
		Partial discharge requirements	As per IEC 60664-1 Annex C
		Solid insulation design	Shall withstand short term and long term stresses as per IEC 60664-1 clause 3.3

* If the internal emission source(s) is operating at a frequency below 9 kHz then measurements need only to be performed up to 230 MHz

NOTE: The tests results shall be as per the Performance Criteria A specified in IEC 61326-1 for the respective tests.

4.2.12. The multimeters shall be used to test both sinusoidal and non-sinusoidal waveforms by using the function True RMS. To ensure the precision of test result, input signal shall be as follows:

- a) AC voltage: > 13 mV
- b) AC current: > 1.3A

4.2.13. The electrical measurement characteristics of the digital clamp on meter shall be as per Table 2.

Table 2 - Measurement characteristics multimeters.

DC VOLTS	
Ranges:	400 mV, 4 V, 40 V, 400 V, 600 V
Resolution:	100 μ V
Accuracy (ranges):	$\pm(0.25\% \text{ rdg} + 1\text{dgt})$ on 400 mV to 400 V $\pm(0.25\% \text{ rdg} + 3\text{dgts})$ on 600 V
Input impedance :	> 10 M Ω
Overload protection:	600 VDC or AC rms
AC VOLTS (True RMS) (50Hz - 500Hz)	
Ranges:	4 V, 40 V, 400 V, 600 V
Resolution:	1 mV
Accuracy:	$\pm (0.75\% \text{ rdg} + 4\text{dgts})$ on 50 - 60Hz $\pm (2.0\% \text{ rdg} + 4\text{dgts})$ on 40 - 500Hz
Input impedance :	> 10 M Ω
Effect Reading:	100 - 3999

Issued by: Head of Section, Technical Standards & Specifications

Signed:

Date: 2014-07-06

Authorized by: Head of Department, Research & Development

Signed:

Date: 2014-07-06



Kenya Power

TITLE:

SPECIFICATION FOR LOW VOLTAGE MEASURING INSTRUMENTS

Part 3: Multimeters

Doc. No.

KP1/3CB/TSP/09/058-3

Issue No.

1

Revision No.

0

Date of Issue

2014-07-06

Page 8 of 24

Overload protection:	600 VDC or 600 VAC rms
RESISTANCE	
Ranges:	400 Ω, 4 kΩ, 40 kΩ, 400 kΩ, 4000 kΩ, 40 MΩ
Accuracy (ranges):	± (0.3% rdg + 5dgts) on 400 Ω ± (0.3% rdg + 1dgt) on 4 kV to 400 kΩ ± (0.5% rdg + 1dgt) on 4000 kΩ ± (2.0% rdg + 4dgts) on 40 MΩ
Open circuit volts:	0.4 Vdc
Overload protection:	600 VDC or AC rms
CONTINUITY	
Audible indication:	less than 40 Ω ± 20 Ω
Overload protection:	600 VDC or AC rms
DIODE TEST	
Test current:	1.0 mA + 0.6 mA
Accuracy:	+ (3.0% rdg + 3dgts)
Open circuit volts:	3.0 Vdc typical
Overload protection:	600 VDC or AC rms
FREQUENCY (Auto ranging)	
Ranges:	100 Hz, 1 kHz, 10 kHz, 100 kHz, 500 kHz
Resolution:	0.01 Hz
Accuracy:	+ (0.1% rdg + 2dgts)
Sensitivity:	2.0 Vrms min
Effect reading:	10 - 9999
Overload protection:	600 VDC or AC rms
CAPACITANCE	
Ranges:	4 nF, 40 nF, 400 nF, 4 mF, 40 mF
Accuracy:	± (3.0% rdg + 20dgts) on 4 nF range (use DZERO) ± (3.0% rdg + 4dgts) on 40 nF to 20 mF ranges ± (6.0% rdg + 4dgts) above 20 mF
Overload protection:	600 VDC or AC rms
DC CURRENT (Put conductor at the center of the jaws)	
Ranges:	400 A, 1200 A
Resolution:	100 mA
Accuracy:	± (1.5% rdg + 5dgts): *700A to 1200A ± (2.0% rdg + 5dgts)
Overload protection:	1200A dc maximum for 1 minute.
AC CURRENT (True RMS) (40 Hz – 500 Hz) (Put conductor at the center of the jaws in case of Clamp-on Multimeter)	
Ranges:	400 A, 1000 A
Resolution:	100 mA
Accuracy:	± (1.75% rdg + 5dgts) on 50 Hz/ 60 Hz ± (3.5% rdg + 5dgts) on 40 Hz – 500 Hz *700A to 1000A: (50Hz/60Hz) ±(2.5% rdg + 5dgts)
Overload protection:	1000 V maximum for 1 minute.

Issued by: Head of Section, Technical Standards & Specifications

Signed:

Date: 2014-07-06

Authorized by: Head of Department, Research & Development

Signed:

Date: 2014-07-06



Kenya Power

TITLE:

SPECIFICATION FOR LOW VOLTAGE MEASURING INSTRUMENTS

Part 3: Multimeters

Doc. No. KP1/3CB/TSP/09/058-3

Issue No. 1

Revision No. 0

Date of Issue 2014-07-06

Page 9 of 24

4.3. Design and Construction

4.3.1. Digital Multimeter

- 4.3.1.1. The digital multimeters (DMM) shall be designed, manufactured and tested in accordance with IEC 61557: Parts 1, 2, 3, 4, 5, 6 & 10 standard requirements. It shall also comply fully with the provisions of clause 4.2 and Table 1 on safety and environmental design requirements and measurement characteristics conforming to Table 2 of this specification
- 4.3.1.2. Digital multimeters (DMM's) shall be used to measure electrical quantities such as voltage, current, resistance, frequency, temperature, capacitance, and time period measurements in order to find electronic and electrical problems.
- 4.3.1.3. The DMM shall have an auto-ranging dial for setting the function to be measured and the instrument count shall be a 3 ¾ - digit, 4,000 count display device with a DC Voltage accuracy of ± (0.5 % reading + 5 digits).
- 4.3.1.4. The provision of advanced multimeter functional features to make measurement of electrical systems and components easier shall be stated by the manufacturer and shall be accepted e.g. Direct Key Selection or Menu Selection.
- 4.3.1.5. Digital multimeters in this specification shall be handheld and shall be specifically designed to be used while holding, i.e. can be operated with one hand.
- 4.3.1.6. The digital multimeters shall have the following features as per Table 3 and various functionalities and test features as per Table 4:

Table 3: Functionalities and test features of the DMM

Feature	Function
Audible continuity	Will give an indication to the user that a closed loop exists due to the probes touching each other through beeping
Diode test	will check to see if a diode is good or bad
Maximum or minimum or peak spike measurement	Measure and display when these events occur.
Resistance temperature detectors RTD or thermocouple probe.	Measure temperatures
Transistor test	Capable of examining a transistor and tell where the emitter, collector, and base is located
Battery level	Indicates the level of battery operation available.
Breakdown indicator	Indicates that breakdown mode is in operation

Issued by: Head of Section, Technical Standards & Specifications

Signed:

Date: 2014-07-06

Authorized by: Head of Department, Research & Development

Signed:

Date: 2014-07-06

Feature	Function
High-voltage indicator	Indicates the presence of high voltage during operation.
Digital display	Displays the reading during a test.
Digital bar graph	Displays measurement signals visually.
dB readings	Measure and display units of sound pressure
Auto-ranging	Automatically choose the measurement range
Adjustable sampling rate	Provide most comprehensive measuring ranges and features
Programmable, data acquisition, storage and logging	Operation using typed commands, by programming the remote system
Removable data storage and triggering	Continuously mounted backup storage media.

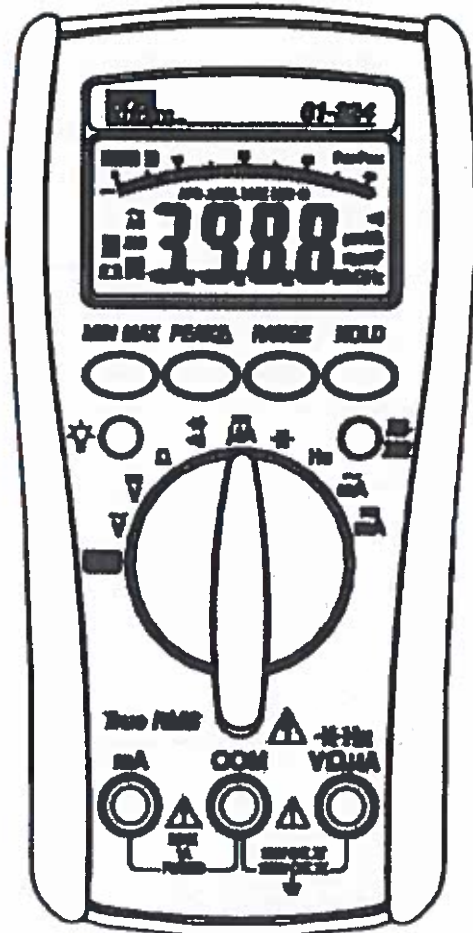

Fig. 1a: Design features of DMM



Fig. 1b: LCD Display Window

Issued by: Head of Section, Technical Standards & Specifications

Signed: 

Date: 2014-07-06

Authorized by: Head of Department, Research & Development

Signed: 

Date: 2014-07-06



TITLE:
SPECIFICATION FOR LOW VOLTAGE MEASURING INSTRUMENTS
 Part 3: Multimeters

Doc. No. KP1/3CB/TSP/09/058-3
Issue No. 1
Revision No. 0
Date of Issue 2014-07-06
 Page 11 of 24

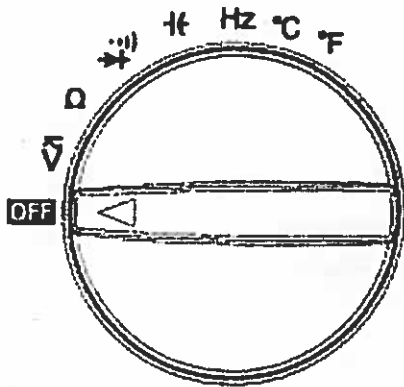

Fig. 1c: Auto Ranging Meter

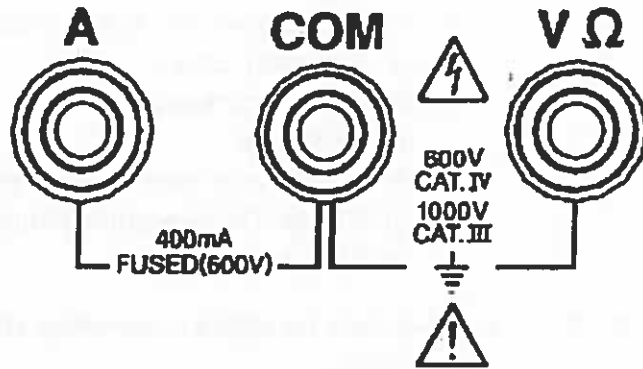

Fig. 1d: DMM Input Jacks or Ports

Table 4: Description of symbols and measurement functions to be used on the DMM

Symbols	Measurement Functions	Descriptions
$V \sim$, V_{AC}	AC Voltage	Measures amount of AC Electrical Pressure
$V \text{---}$, V_{DC}	DC Voltage	Measures amount of DC Electrical Pressure
mV	Milli Volts	.001 V or 1/1000 V
A	Amperes	Measures amount of electron flow
mA	Milli Amperes	.001 A or 1/1000 A
μA	Micro Amperes	.000001 A or 1/1000000
Ω	Ohms	Measurement of resistance to the flow of electron
$\text{—} $	Diode	Device used to control direction of electrical flow
$\text{—})$	Audible Continuity	Audible indication of continuity for low resistance
$\text{—} $	Capacitance	Device used to store electrical potential
HZ	Hertz	Measurement of frequency or number of cycles per second
$^{\circ}F$	Degrees Fahrenheit	Temperature measurement
$^{\circ}C$	Degrees Celsius	Temperature measurement

NOTE: Devices with battery power shall have an option of being operated without plug-in power.

4.3.1.7. Specific measurements made by digital multimeters shall include:

- a) DC & AC voltage,
- b) DC & AC current,
- c) Resistance,
- d) Capacitance,

Issued by: Head of Section, Technical Standards & Specifications

Signed:

Date: 2014-07-06

Authorized by: Head of Department, Research & Development

Signed:

Date: 2014-07-06



TITLE:

SPECIFICATION FOR LOW VOLTAGE MEASURING INSTRUMENTS

Part 3: Multimeters

Doc. No.	KP1/3CB/TSP/09/058-3
Issue No.	1
Revision No.	0
Date of Issue	2014-07-06
Page 12 of 24	

- e) Frequency range,
- f) Time period,
- g) Special measurements that include:
 - (i) Continuity check,
 - (ii) Audible continuity,
 - (iii) Diode test,
 - (iv) Maximum or minimum or peak spike measurement,
 - (v) RTD or Thermocouple temperature measurement,
 - (vi) Transistor test.

4.3.1.8. Output options for digital multimeters shall include :

- a) GPIB,
- b) IEEE 488,
- c) RS232,
- d) BCD, and
- e) D/A.

4.3.2. Digital Clamp-On Meter

4.3.2.1. The digital multimeters (DMM) shall be designed, manufactured and tested in accordance with IEC 61557: Parts 1, 2, 3, 4 & 10 standard requirements. It shall also comply fully with the provisions of clause 4.2 and Table 1 of this specification.

4.3.2.2. This shall be a portable, 'single-hand operation' AC/DC digital clamp meter with an LCD display and back light for easy reading.

4.3.2.3. The general features required for the clamp-on meter shall be as per Table 4 with component parts and functionalities as per Fig. 2 and Table 5:

Table 4: General specifications

Functionality	Description
Display	LCD , 3¾, digit (4000 counts), 9999 counts (Frequency mode), 40 segments analog bar graph and function units sign annunciators
Polarity	Automatic, positive implied, negative polarity indication.
Over range	"4000 "or" 4000" Most Significant Digit blinks.
Low battery indication	The "  " is displayed when the battery voltage drops below the operating level.
Measurement rate	2/sec, nominal. 1/sec, Capacitance and Frequency mode. 20/sec, Analog display.

Issued by: Head of Section, Technical Standards & Specifications

Signed: 

Date: 2014-07-06

Authorized by: Head of Department, Research & Development

Signed: 

Date: 2014-07-06

Functionality	Description
Accuracy	Stated accuracy at 23°C + 5°C, <75% relative humidity.
Auto Power off	30minutes after rotary switch or mode changes.
Clamp jaw	According to IEC 61010-2-032 CAT IV 600V.
Power	Single standard 9 volt battery, designation IEC 6F22 as per IEC 60086-2
Battery life	150 hours typical with carbon zinc
Dimensions	Approx. 250mm (H) x 100mm (W) x 46mm (D).
Weight	Approx. 380g including battery.
Accessories	One pair of test leads, 9V battery (installed).

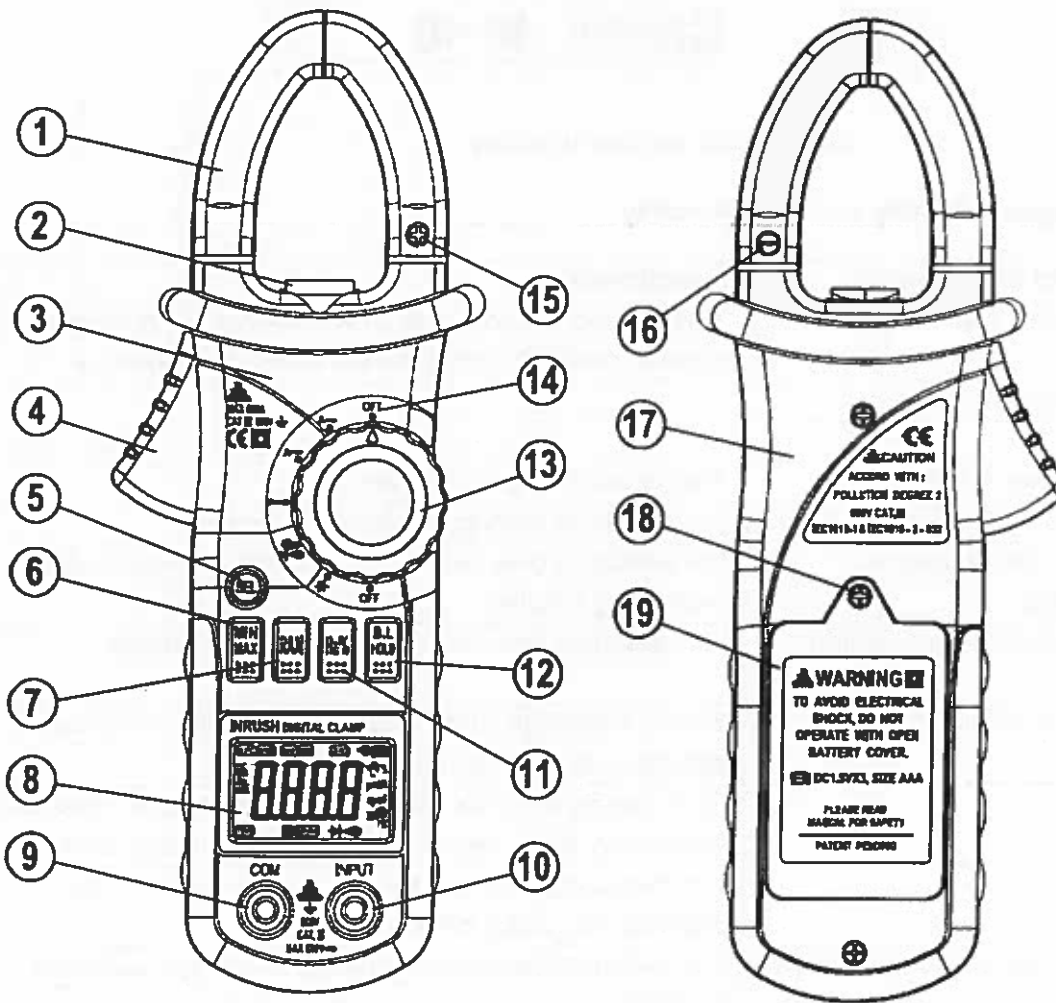



Fig. 2: Component parts of Clamp on Meter

Issued by: Head of Section, Technical Standards & Specifications

Signed: 

Date: 2014-07-06

Authorized by: Head of Department, Research & Development

Signed: 

Date: 2014-07-06

4.3.2.4. The Light Crystal Display (LCD) shall resemble Fig. 2, with all the functions appearing on the screen as shown in Fig. 3 and LCD functionalities described in Table 6.

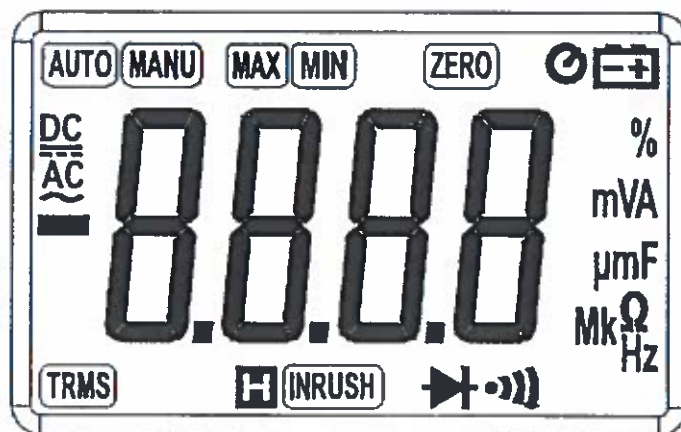

Fig. 3: LCD display window

Table 5: Component Parts and Functionality

No.	Names of components	Functionality
1	Transformer jaw	This is used to sense the current signal. To measure DC/AC current, conductor must be enclosed by the jaw.
2	Clamp Lighting Bulb	
3	Panel	
4	Transformer Trigger	This is used to open the jaw.
5	Function Switch Button (SEL)	For switching among measuring functions
6	Max/Min Switch Button (MAX/MIN)	For switching between maximum and minimum value measuring function
7	Auto/Manual Switch Button (RAN)	For switching between auto and manual ranges.
8	Liquid Crystal Display	This is a 3 1/2 digit liquid crystal display with maximum indication of 4000 counts.
9	COM Jack	Common input connection for current, voltage, resistance, frequency, duty, capacitance, diode, continuity measurement
10	Input Jack	For measuring voltage, resistance, frequency, duty, capacitance, diode, and continuity
11	Hz/Duty Switch Button (Hz/%)	For switching between frequency and duty measuring functions.
12	Reading Hold/Back Light Button (HOLD/B.L)	For holding the reading or control backlight

Issued by: Head of Section, Technical Standards & Specifications

Signed:

Date: 2014-07-06

Authorized by: Head of Department, Research & Development

Signed:

Date: 2014-07-06



Kenya Power

TITLE:

SPECIFICATION FOR LOW VOLTAGE MEASURING INSTRUMENTS

Part 3: Multimeters

Doc. No.

KP1/3CB/TSP/09/058-3

Issue No.

1

Revision No.

0

Date of Issue

2014-07-06

Page 15 of 24

No.	Names of components	Functionality
13	Rotary selector	For selecting functions and ranges
14	OFF – power switch	For turning off the power.
15	"+" Symbol	Polarity indication – positive polarity
16	"-" Symbol	Polarity indication – negative polarity
17	Rear Case	Rear instrument cover
18	Fixing Screw of Battery Cover	Hold the batteries cover firmly in position
19	Battery Cover	Secure the batteries

Table 6: LCD functionalities to be used in Clamp-On Multimeters

Symbol	Description
	Alternating current
	Direct current
	Diode test
	Continuity buzzer
AUTO	Auto range mode
MANU	Manual range mode
MAX	The maximum value is being measured
MIN	The minimum value is being measured.
ZERO	DCA zero
	Auto power off
	Battery low
TRMS	True RMS
H	This indicates that the display data is being held.
INRUSH	Inrush current is being measured.
%	Percent (Duty cycle)
mV, V	Milli-volts, Volts (Voltage)
A	Amperes (Current)
µF, mF	Micro-farad, Milli-farad (Capacitance)
Ω, kΩ, MΩ	Ohms, Kilo-ohms, Mega-ohms (Resistance)
Hz, kHz	Hertz, Kilo-hertz (Frequency)

Issued by: Head of Section, Technical Standards & Specifications

Signed:

Date: 2014-07-06

Authorized by: Head of Department, Research & Development

Signed:

Date: 2014-07-06



Kenya Power

TITLE:

**SPECIFICATION FOR LOW
VOLTAGE MEASURING
INSTRUMENTS**

Part 3: Multimeters

Doc. No. KP1/3CB/TSP/09/058-3

Issue No. 1

Revision No. 0

Date of Issue 2014-07-06

Page 16 of 24

4.4. Quality Management System

- 4.4.1. The supplier shall submit a quality assurance plan (QAP) that will be used to ensure that the low voltage multimeter design, physical properties, tests and documentation, will fulfill the requirements stated in the contract documents, standards, specifications and regulations. The QAP shall be based on and include relevant parts to fulfill the requirements of ISO 9001:2008.
- 4.4.2. The Manufacturer's Declaration of Conformity to applicable standards and copies of quality management certifications including copy of valid and relevant ISO 9001: 2008 certificate shall be submitted with the tender for evaluation.
- 4.4.3. The bidder shall indicate the delivery time of the items, manufacturer's monthly & annual production capacity and experience in the production of the type and size of items being offered. A detailed list & contact addresses (including e-mail) of the manufacturer's previous customers for similar type of the low voltage multimeters sold in the last five years as well as reference letters from at least four of the customers shall be submitted with the tender for evaluation.

5.0. TESTS AND INSPECTION

- 5.1. The low voltage multimeters shall be inspected and tested in accordance with the requirements of IEC 61010-1, IEC 61010-2-030, IEC 61326-2-2, and IEC 61557: Parts 1, 2, 3,4,5,6 & 10 standards and provisions of clause 4.2.1 Table 1 & 2 of this specification. It shall be the responsibility of the supplier to perform or to have performed the tests specified and whatever other tests he normally performs at works.
- 5.2. Copies of previous Type Tests Reports issued by a third party testing laboratory that is accredited to ISO/IEC 17025 shall be submitted with the tender for the purpose of technical evaluation. The accreditation certificate to ISO/IEC 17025 for the same third party testing laboratory used shall also be submitted with the tender document (all in English Language).
- 5.3. Copies of type test reports to be submitted with the tender (by bidder) for evaluation shall be as stated below:
- a) Type tests for the instrument performance
- Electromagnetic compatibility (EMC)
 - Impulse overvoltage tests on the equipment -Clearances
 - Dielectric voltage withstand tests on the equipment - Controlled overvoltage
 - Functional tests of the equipment

Issued by: Head of Section, Technical Standards & Specifications

Signed:

Date: 2014-07-06

Authorized by: Head of Department, Research & Development

Signed:

Date: 2014-07-06



Kenya Power

TITLE:

SPECIFICATION FOR LOW VOLTAGE MEASURING INSTRUMENTS

Part 3: Multimeters

Doc. No. KP1/3CB/TSP/09/058-3

Issue No. 1

Revision No. 0

Date of Issue 2014-07-06

Page 17 of 24

b) Type tests for printed circuit board coating performance

- Environmental, humidity and thermal conditioning tests
- Dielectric voltage withstand tests
- Comparative tracking index (CTI)
- Resistance to soldering heat
- Coating adhesion
- Insulation resistance between conductors

5.4. Routine and sample test reports for the low voltage measurement instruments to be supplied shall be submitted to KPLC for approval before shipment/delivery of the goods. KPLC Engineers will witness tests at the factory before shipment.

5.5. Tests to be witnessed at the factory before shipment shall be in accordance with IEC 61557: Parts 1,2,3,4,5,6,7 & 10 standards and provisions of clause 4.2 and Table 1 of this specification and shall include the following:

- a) Visual inspection
- b) Performance test
- c) Influence of position tests
- d) Influence of the supply voltage tests
- e) Battery check facility tests
- f) Marking and operating instructions verifications.

5.6. On receipt of the goods KPLC will perform any of the tests specified in order to verify compliance with this specification. The supplier shall replace without charge to KPLC the low voltage measurement instruments, which upon examination, test or use; fail to meet any of the requirements in the specification.

6.0. MARKING AND PACKING

6.1. Marking

Markings shall comply with IEC 61010-1 unless otherwise specified in other parts of IEC 61557. The measuring equipment shall carry the following marking which shall be clearly readable and indelible (in English Language).

- a) Type of equipment.
- b) Units of the measured quantity.
- c) Ranges of measurement.
- d) Type and current rating of the fuse in the case of exchangeable fuses.
- e) Type of battery/accumulator and polarity of connection in the battery compartment.

Issued by: Head of Section, Technical Standards & Specifications

Signed:

Date: 2014-07-06





Authorized by: Head of Department, Research & Development

Signed:

Date: 2014-07-06

- f) Nominal voltage of the distribution system and the symbol for double insulation in accordance with IEC 61010-1 for measuring equipment with distribution system power supply.
- g) Manufacturer's name or registered trade mark.
- h) Model number, name or other means to identify the equipment (inside or outside).
- i) The words "PROPERTY OF KPLC".
- j) Reference to the operating instructions with the symbol as per Table 8 in accordance with IEC 61010-1.

Table 8: Safety symbols



	Caution, risk of danger (Important safety information - refer to the operation manual.)
	Application around and removal from HAZARDOUS LIVE conductors are permitted. IEC 60417- 5036
	Double insulation (Protection Class II) - IEC 60417- 5172
CAT III	Overvoltage (Installation) category III, Pollution Degree 2 per IEC 61010-1 refers to the level of Impulse Withstand Voltage protection provided.
	Conforms to European Union Directive
	Earth (ground) terminal – IEC 60417 - 5017

6.2. PACKING

- 6.2.1. The low voltage multimeters shall be packed in a standard rugged heavy duty robust case with cushion grip handles and rubberized gripping surface for outdoor use (protection category IP X5) in such a manner to avoid damage during transportation.
- 6.2.2. The housing shall be complete with a gasket to seals the lid when closed so as to protect the instrument against water and dirt while the instrument is carried through rainstorms or other hazardous conditions. The lid shall be secured by two latches and a handle for portability. A compartment shall also be provided for storage of test cables and line cord.

7.0. DOCUMENTATION

- 7.1. The bidder shall submit its tender complete with technical documents required by Annex A (Guaranteed Technical Particulars) for tender evaluation. The technical documents to be submitted (all in English language) for tender evaluation shall include the following:
 - a) Fully filled clause by clause guaranteed technical particulars (GTP) signed by the manufacturer;

Issued by: Head of Section, Technical Standards & Specifications	Authorized by: Head of Department, Research & Development
Signed: 	Signed: 
Date: 2014-07-06	Date: 2014-07-06



Kenya Power

TITLE:

SPECIFICATION FOR LOW VOLTAGE MEASURING INSTRUMENTS

Part 3: Multimeters

Doc. No. KP1/3CB/TSP/09/058-3

Issue No. 1

Revision No. 0

Date of Issue 2014-07-06

Page 19 of 24

- b) Copies of the Manufacturer's catalogues, brochures, drawings and technical data;
- c) Sales records for the last five years and at least four customer reference letters;
- d) Details of manufacturing capacity and the manufacturer's experience;
- e) Copies of required type test reports by a third party testing laboratory accredited to ISO/IEC 17025;
- f) Copy of accreditation certificate to ISO/IEC 17025 for the third party testing laboratory;
- g) Manufacturers letter of authorization, ISO 9001:2008 certificate and other technical documents required in the tender.
- h) Operating instructions:
The operating uncertainty, the intrinsic uncertainty and the variations E1 to E10 shall be provided in the operating instructions.

In addition, the operating instructions shall comprise the following details:

- (i) Connection diagrams.
- (ii) Instructions for measurements.
- (iii) Brief description of the principle of measurement.
- (iv) Diagrams or tables showing the maximum permissible indicated values taking into consideration the tolerances stated by the manufacturer (if necessary).
- (v) Type of battery/rechargeable cells.
- (vi) Information on the charging current, charging voltage and duration of charging for rechargeable cells.
- (vii) Operational lifetime/runtime of the battery/rechargeable cells or the possible number of measurements.
- (viii) Type of IP protection (IEC 60529).
- (ix) Any necessary special guidance notes.

7.2. The successful bidder (supplier) shall submit the following documents/details to The Kenya Power & Lighting Company for approval before manufacture:

- a) Fully filled clause by clause guaranteed technical particulars (GTP) signed by the manufacturer;
- b) Design Drawings with details of low voltage measurement instruments to be manufactured for KPLC.
- c) Quality assurance plan (QAP) that will be used to ensure that the design, material; workmanship, tests, service capability, maintenance and documentation will fulfill the requirements stated in the contract documents, standards, specifications and regulations. The QAP shall be based on and include relevant parts to fulfill the requirements of ISO 9001:2008
- d) Detailed test program to be used during factory testing;

Issued by: Head of Section, Technical Standards & Specifications

Signed:

Date: 2014-07-06

Authorized by: Head of Department, Research & Development

Signed:

Date: 2014-07-06



Kenya Power

TITLE:

**SPECIFICATION FOR LOW
VOLTAGE MEASURING
INSTRUMENTS**

Part 3: Multimeters

Doc. No. KP1/3CB/TSP/09/058-3

Issue No. 1

Revision No. 0

Date of Issue 2014-07-06

Page 20 of 24

e) All documentation necessary for safety of the equipment as specified in IEC 61010-1 clause 5.4 shall be provided with the instrument.

7.3. The supplier shall submit recommendations for use, care, storage and routine inspection/testing procedures, all in the English Language, during delivery of the low voltage multimeters to KPLC stores.

-----PAGE LEFT BLANK-----

Issued by: Head of Section, Technical Standards & Specifications

Signed:

Date: 2014-07-06

Authorized by: Head of Department, Research & Development

Signed:

Date: 2014-07-06



Kenya Power

TITLE:

SPECIFICATION FOR LOW VOLTAGE MEASURING INSTRUMENTS

Part 3: Multimeters

Doc. No. KP1/3CB/TSP/09/058-3

Issue No. 1

Revision No. 0

Date of Issue 2014-07-06

Page 21 of 24

ANNEX A: *Guaranteed Technical Particulars (to be filled and signed by the supplier and submitted together with copies of the Manufacturer's catalogues, brochures, drawings, technical data, sales records and copies of test certificates for tender evaluation)*

Tender No Bidder's Name & Address

Sr. No.	Description	Bidder's Offer (To be fully filled)
1	Name of the manufacturer and country of origin	
	Type Reference Number or Model Number	
2	Applicable Standards	
3	Terms and Definitions	
4	Requirements	
4.1	Service conditions	
4.2	Design and Construction	
	4.2.1 – 4.2.13	

Table 3: Power Supply and Mechanical Data as per Table 3

Single-phase, nominal	220 V AC ... 250 V AC, 16 A
Frequency, nominal	50 Hz
Power consumption	<3500 VA (<7000 VA for short time < 10 sec)
Connection socket	C22 conforming to IEC 60320
Operating temperature	-10 ... +55 °C (+14 ... +131 °F)
Storage temperature	-20 ... +70 °C (-4 ... +158 °F)
Humidity range - Rel. humidity	5 ... 95 %, non-condensing
Shock (operating)	15 g / 11 ms half sine as per IEC 60068-2-27
Vibration (operating)	frequency range from 10 Hz to 150 Hz, continuous acceleration 2 g (20 m/s ²), 10 cycles per axis as per IEC 60068-2-6
Performance criteria of the equipment	IEC 61326-1 Class A,
Rated Impulse Voltage for equipment - 1.2/50µs	6000 V as per IEC 60664-1, table 1
Overvoltage category	Class IV as per IEC 61010-1
Pollution category	Class 2 as per IEC 61010-1
Insulation material group	Group II - 400≤CTI<600 (PLC=1) as per IEC 60112

Issued by: Head of Section, Technical Standards & Specifications

Signed:

Date: 2014-07-06

Authorized by: Head of Department, Research & Development

Signed:

Date: 2014-07-06



Kenya Power

TITLE:

SPECIFICATION FOR LOW VOLTAGE MEASURING INSTRUMENTS

Part 3: Multimeters

Doc. No. KP1/3CB/TSP/09/058-3

Issue No. 1

Revision No. 0

Date of Issue 2014-07-06

Page 22 of 24

Partial discharge requirements	As per IEC 60664-1 Annex C	
Solid insulation design	Shall withstand short term and long term stresses as per IEC 60664-1 clause 3.3	

Measurement characteristics multimeters

DC VOLTS		
Ranges:	400 mV, 4 V, 40 V, 400 V, 600 V	
Resolution:	100 μ V	
Accuracy (ranges):	$\pm(0.25\% \text{ rdg} + 1\text{dgt})$ on 400 mV to 400 V $\pm(0.25\% \text{ rdg} + 3\text{dgts})$ on 600 V	
Input impedance :	> 10 M Ω	
Overload protection:	600 VDC or AC rms	
AC VOLTS (True RMS) (50Hz - 500Hz)		
Ranges:	4 V, 40 V, 400 V, 600 V	
Resolution:	1 mV	
Accuracy:	$\pm (0.75\% \text{ rdg} + 4\text{dgts})$ on 50 - 60Hz $\pm (2.0\% \text{ rdg} + 4\text{dgts})$ on 40 - 500Hz	
Input impedance :	> 10 M Ω	
Effect Reading:	100 – 3999	
Overload protection:	600 VDC or 600 VAC rms	
RESISTANCE		
Ranges:	400 Ω , 4 k Ω , 40 k Ω , 400 k Ω , 4000 k Ω , 40 M Ω	
Accuracy (ranges):	$\pm (0.3\% \text{ rdg} + 5\text{dgts})$ on 400 Ω $\pm (0.3\% \text{ rdg} + 1\text{dgt})$ on 4 kV to 400 k Ω $\pm (0.5\% \text{ rdg} + 1\text{dgt})$ on 4000 k Ω $\pm (2.0\% \text{ rdg} + 4\text{dgts})$ on 40 M Ω	
Open circuit volts:	0.4 Vdc	
Overload protection:	600 VDC or AC rms	
CONTINUITY		
Audible indication:	less than 40 $\Omega \pm 20 \Omega$	
Overload protection:	600 VDC or AC rms	
DIODE TEST		
Test current:	1.0 mA + 0.6 mA	
Accuracy:	+ (3.0% rdg + 3dgts)	
Open circuit volts:	3.0 Vdc typical	
Overload protection:	600 VDC or AC rms	
FREQUENCY (Auto ranging)		
Ranges:	100 Hz, 1 kHz, 10 kHz, 100 kHz, 500 kHz	
Resolution:	0.01 Hz	
Accuracy:	+ (0.1% rdg + 2dgts)	

Issued by: Head of Section, Technical Standards & Specifications

Signed:

Date: 2014-07-06

Authorized by: Head of Department, Research & Development

Signed:

Date: 2014-07-06



Kenya Power

TITLE:

SPECIFICATION FOR LOW VOLTAGE MEASURING INSTRUMENTS

Part 3: Multimeters

Doc. No. KP1/3CB/TSP/09/058-3

Issue No. 1

Revision No. 0

Date of Issue 2014-07-06

Page 23 of 24

Sensitivity:	2.0 Vrms min
Effect reading:	10 - 9999
Overload protection:	600 VDC or AC rms
CAPACITANCE	
Ranges:	4 nF, 40 nF, 400 nF, 4 mF, 40 mF
Accuracy:	± (3.0% rdg + 20dgts) on 4 nF range (use DZERO) ± (3.0% rdg + 4dgts) on 40 nF to 20 mF ranges ± (6.0% rdg + 4dgts) above 20 mF
Overload protection:	600 VDC or AC rms
DC CURRENT (Put conductor at the center of the jaws)	
Ranges:	400 A, 1200 A
Resolution:	100 mA
Accuracy:	± (1.5% rdg + 5dgts): *700A to 1200A ± (2.0% rdg + 5dgts)
Overload protection:	1200A dc maximum for 1 minute.
AC CURRENT (True RMS) (40 Hz – 500 Hz)	
Ranges:	400 A, 1000 A
Resolution:	100 mA
Accuracy:	± (1.75% rdg + 5dgts) on 50 Hz/ 60 Hz ± (3.5% rdg + 5dgts) on 40 Hz – 500 Hz *700A to 1000A: (50Hz/60Hz) ±(2.5% rdg + 5dgts)
Overload protection:	1000 V maximum for 1 minute.
4.3	Design and construction
4.3.1	Digital Multimeter
	4.3.1.1 – 4.3.1.8
4.3.2	Digital clamp-On Meter
	4.3.2.1 – 4.3.2.4
4.4	Quality Management Systems
	4.4.1 – 4.4.3
5.0	Test and Inspection
	5.1 – 5.3
	5.3.1 – Types tests for the instrument performance
	5.3.2. - Types tests for the printed circuit coating performance
	5.4 – 5.6
6.0	Marking and packing
	6.1 Packing
	6.1.1 – 6.1.3

Issued by: Head of Section, Technical Standards & Specifications

Signed:

Date: 2014-07-06

Authorized by: Head of Department, Research & Development

Signed:

Date: 2014-07-06



Kenya Power

TITLE:

SPECIFICATION FOR LOW VOLTAGE MEASURING INSTRUMENTS

Part 3: Multimeters

Doc. No. KP1/3CB/TSP/09/058-3

Issue No. 1

Revision No. 0

Date of Issue 2014-07-06

Page 24 of 24

	6.2 Marking	
7.0	Documentation	
	7.2– 7.3	
8.0	Manufacturer's Guarantee and Warranty	
9.0	List catalogues, brochures, technical data and drawings submitted to support the offer.	
10.0	List customer sales records submitted to support the offer.	
11.0	List Test Reports and Test Certificates submitted with tender	
12.0	List test & calibration reports to be submitted to KPLC for approval before shipment	
13.0	Statement of compliance to specification (indicate deviations if any & supporting documents)	

.....
Manufacturer's Name, Signature, Stamp and Date

Issued by: Head of Section, Technical Standards & Specifications

Signed:

Date: 2014-07-06

Authorized by: Head of Department, Research & Development

Signed:

Date: 2014-07-06