



Kenya Power

TITLE:

**SPECIFICATION FOR  
OVERHEAD LINES  
LOAD HANDLING DEVICES**

Part 2: Sisal Ropes and Fibre  
Slings

Doc. No.

KP1/3CB/TSP/09/060-2

Issue No.

1

Revision No.

0

Date of Issue

2014-07-08

Page 1 of 26

**TABLE OF CONTENTS**

**0.1 Circulation List**

**0.2 Amendment Record**

**FOREWORD**

1. SCOPE
2. REFERENCES
3. TERMS AND DEFINITIONS
4. REQUIREMENTS
5. TESTS AND INSPECTION
6. MARKING, PACKING AND LABELLING
7. DOCUMENTATION

**ANNEX A:** *Guaranteed Technical Particulars (to be filled and signed by the Manufacturer and submitted together with relevant copies of the Manufacturer's catalogues, brochures, drawings, technical data, sales records for previous five years, four customer reference letters, details of manufacturing capacity, the manufacturer's experience and copies of complete type test certificates and type test reports for tender evaluation, all in English Language)*

Issued by:  Head of Section Tech Stds & Specs

Signed:

Date: 2014-07-08

Authorized by: Head of Department, R & D

Signed: 

Date: 2014-07-08



**TITLE:**

**SPECIFICATION FOR  
OVERHEAD LINES  
LOAD HANDLING DEVICES**

**Part 2: Sisal Ropes and Fibre  
Slings**

**Doc. No.**

**KP1/3CB/TSP/09/060-2**

**Issue No.**

**1**

**Revision No.**

**0**

**Date of Issue**

**2014-07-08**

Page 2 of 26

**0.1 Circulation List**

<b>COPY NO.</b>	<b>COPY HOLDER</b>
1	Research & Development Manager
2	Supply Chain Manager (Procurement)
Electronic copy (pdf) on Kenya Power server ( <a href="http://172.16.1.40/dms/browse.php?FolderId=23">http://172.16.1.40/dms/browse.php?FolderId=23</a> )	

**0.2 Amendment Record**

<b>Rev No.</b>	<b>Date (YYYY-MM-DD)</b>	<b>Description of Change</b>	<b>Prepared by (Name &amp; Signature)</b>	<b>Approved by (Name &amp; Signature)</b>
0	2014-07-08	New Issue	Michael Apudo	Eng. Simon Kimitei

**Issued by: Head of Section Tech Stds & Specs**

**Authorized by: Head of Department, R & D**

**Signed:**

**Signed:**

**Date: 2014-07-08**

**Date: 2014-07-08**



Kenya Power

TITLE:

**SPECIFICATION FOR  
OVERHEAD LINES  
LOAD HANDLING DEVICES**

Part 2: Sisal Ropes and Fibre  
Slings

Doc. No.

KP1/3CB/TSP/09/060-2

Issue No.

1

Revision No.

0

Date of Issue

2014-07-08

Page 3 of 26

**FOREWORD**

This specification has been prepared by the Research and Development Department in collaboration with Distribution Division, both of The Kenya Power and Lighting Company Limited (KPLC) and it lays down requirements for overhead lines load handling devices (fibre slings and sisal ropes) for use on power lines. It is intended for use by KPLC in purchasing of the item.

It shall be the responsibility of the manufacturer to ensure adequacy of the design and good engineering practice in the manufacture of the fiber slings and sisal ropes for KPLC. The supplier shall also submit information which confirms satisfactory service experience of the manufacturer with products which fall within the scope of this specification.

**1. SCOPE**

1.1. This specification is for fibre slings and sisal ropes for use on overhead power lines by the Operation and Maintenance teams in KPLC. These shall include:

- a) Sisal Ropes
- b) Fibre Slings
  - i) Endless flexible roundsling.
  - ii) Flat woven endless webbing sling.

1.2. The specification also covers inspection and test of the fibre slings and sisal ropes as well as schedule of Guaranteed Technical Particulars to be filled, signed by the manufacturer and submitted for tender evaluation.

1.3. The specification stipulates the minimum requirements for fibre slings and sisal ropes; acceptable for use in the company and it shall be the responsibility of the supplier to ensure adequacy of the design, good engineering practice, adherence to the specification and applicable standards and regulations as well as ensuring good workmanship in the manufacture of the fibre slings and sisal ropes for The Kenya Power & Lighting Company.

The specification does not purport to include all the necessary provisions of a contract.

Issued by: Head of Section Tech Stds & Specs

Authorized by: Head of Department, R & D

Signed:

Signed:

Date: 2014-07-08

Date: 2014-07-08



Kenya Power

TITLE:

**SPECIFICATION FOR  
OVERHEAD LINES  
LOAD HANDLING DEVICES**

Part 2: Sisal Ropes and Fibre  
Slings

Doc. No.

KP1/3CB/TSP/09/060-2

Issue No.

1

Revision No.

0

Date of Issue

2014-07-08

Page 4 of 26

**2. REFERENCES**

The following standards contain provisions which, through reference in this text constitute provisions of this specification. Unless otherwise stated, the latest editions (including amendments) apply:

ISO 9554: Fibre ropes — General specifications

ISO 2307: Fibre ropes -- Determination of certain physical and mechanical properties.

ISO 1833-1: Textiles – Quantitative chemical analysis – Part 1: General principles of testing

ISO 1140: Fibre ropes -- Polyamide -- 3-, 4-, 8- and 12-strand ropes

ISO 5084: Textiles – Determination of thickness of textiles and textile products

EN 1492: Textile slings. Safety. Part 1: Flat woven webbing slings made of man-made fibres for general purpose use --Part 2: Round slings, made of man-made fibres, for general purpose use.

EN1677: Components for Slings – Safety

**3. TERMS AND DEFINITIONS**

For the purposes of this specification the definitions given in the reference standards shall apply.

**4. REQUIREMENTS**

**4.1. SERVICE CONDITIONS**

These fibre slings and sisal ropes shall be tropicalized, designed and constructed for continuous outdoor operation in tropical areas and harsh climatic conditions including areas exposed to:

- a) Sea spray (along the coast),
- b) Humidity of up to 95% and
- c) Average ambient temperature of +30°C with a minimum of -1°C and a maximum of +40°
- d) Altitude of up to 2000m above the sea level

Issued by: Head of Section Tech Stds & Specs

Authorized by: Head of Department, R & D

Signed:

Signed:

Date: 2014-07-08

Date: 2014-07-08



Kenya Power

TITLE:

**SPECIFICATION FOR  
OVERHEAD LINES  
LOAD HANDLING DEVICES**

Part 2: Sisal Ropes and Fibre  
Slings

Doc. No.

KP1/3CB/TSP/09/060-2

Issue No.

1

Revision No.

0

Date of Issue

2014-07-08

Page 5 of 26

## 4.2. PARTICULAR REQUIREMENTS

### 4.2.1. Sisal Ropes

#### 4.2.1.1. Construction and structure

4.2.1.1.1. The sisal rope shall be made exclusively of new fibres of the sisal hemp plant in accordance with ISO 9554:2005.

**NOTE:** Attention is drawn to the different resistance of man-made fibres to chemicals, which are summarized in annex B of Table A.1.

4.2.1.1.2. The sisal rope shall be a 3-strand laid ropes with a Z-twist (right-hand lay); their strands shall be S-twist and their roping yarns Z-twist in accordance with ISO 9554:2005.

4.2.1.1.3. The fibres within each of the three strands must twist in the opposite direction as the strands in order to produce a balanced rope, that is, one which hangs straight and resists kinking.

4.2.1.1.4. The ropes and their strands shall be continuous, without splice for standard delivered lengths or shorter lengths

#### 4.2.1.2. Treatment

4.2.1.2.1. The sisal rope shall be treated with a cordage oil lubricant of suitable quality. The lubricant shall not impart an offensive odour to the finished rope. The percentage of extractable matter based on the dry weight of the rope shall not be more than 11.5 % for an un-oiled product.

4.2.1.2.2. The rope shall be free from any oils and sold as un-oiled rope. Anti-bacterial additives for sisal shall be added to extend the performance of the natural fibre.

4.2.1.2.3. The twisted rope shall be fused and taped on each end to prevent unravelling and it shall have excellent resistance to sunlight, little stretch and good knot-holding ability.

#### 4.2.1.3. Workmanship and finish

4.2.1.3.1. The finished rope shall contain no cuts, kinks, soft spots caused by change in lay or pitch length, hockles, chafed or damaged sections, or broken, loose or projecting ends in the rope or the strands.

Issued by: Head of Section Tech Stds & Specs

Authorized by: Head of Department, R & D

Signed:

Signed:

Date: 2014-07-08

Date: 2014-07-08



TITLE:

**SPECIFICATION FOR  
OVERHEAD LINES  
LOAD HANDLING DEVICES**

Part 2: Sisal Ropes and Fibre Slings

Doc. No.

KP1/3CB/TSP/09/060-2

Issue No.

1

Revision No.

0

Date of Issue

2014-07-08

Page 6 of 26

4.2.1.3.2. The unspliced ends of all ropes shall be cut off squarely and shall be securely whipped, taped or heat-sealed.

4.2.1.4. Lay length or pitch length

The manufacturer shall establish the lay length or the pitch length of the rope according to its intended use, and/or based upon the purchaser's (KPLC) acceptance.

**NOTE:** For a given reference number of rope, the smaller the lay or pitch length the harder the rope will be; this hardness can affect the estimated breaking strength of the rope.

4.2.1.5. Requirements

4.2.1.5.1. The main requirements shall be those specified in the relevant International, European or Kenyan Standard for the product and shall include the following as per Table 1:

- a) Linear density;
- b) Minimum breaking force;
- c) Reference number.

4.2.1.5.2. The corresponding methods of test are specified in ISO 2307. Other requirements, for example the lay length or the pitch length, the diameter of the circumscribed circle and the elongation of the rope under specific tensile conditions, shall be specified, subject to agreement between the manufacturer and the purchaser (KPLC), where applicable with submission of a sample.

4.2.1.6. Required Sizes

The sisal rope shall be supplied in rolls and shall be of the following dimensions, minimum breaking strength, safe working load, weight and roll length as per Table 1:

**Table 1: Sisal Rope characteristics**

Rope Diameter		Minimum Breaking Strength	Safe Load (Safety Factor 12)	Minimum Weight (Linear density)	Roll Length
(in)	(mm)	(kN)	(kN)	(kg/m)	(m)
3/8	10	3.85	0.32	0.06	150
1/2	12.5	7.56	0.63	0.10	100
5/8	16	12.5	1.04	0.19	100
3/4	20	15.4	1.28	0.24	100
1	25	25.6	2.14	0.40	100

Issued by: Head of Section Tech Stds & Specs

Authorized by: Head of Department, R & D

Signed:

Signed:

Date: 2014-07-08

Date: 2014-07-08



Kenya Power

TITLE:

**SPECIFICATION FOR  
OVERHEAD LINES  
LOAD HANDLING DEVICES**

Part 2: Sisal Ropes and Fibre  
Slings

Doc. No.

KP1/3CB/TSP/09/060-2

Issue No.

1

Revision No.

0

Date of Issue

2014-07-08

Page 7 of 26

**4.2.2. Fibre Slings**

**4.2.2.1. General**

Fibre slings in this specification shall be of two types namely:

- a) Endless flexible roundsling,
- b) Flat woven endless webbing sling,

**4.2.2.2. Design and Construction**

4.2.2.2.1. The fibre sling shall consist of a loadbearing core of yarn (of identical parent material), completely enclosed in a woven cover, with or without fittings, (To be specified in tender) manufactured to EN 1492 Part 1 & 2:2000.

4.2.2.2.2. When specified in tender, they shall be supplied as multi-leg sling assembly, consisting of two, three or four identical slings attached to a master link (See Table 2 of EN 1492 Part 1 & 2:2000)

**4.2.2.3. Material requirements**

The fibre slings shall be produced wholly from industrial yarns (of identical parent material) certified by the manufacturer as being fast to light and heat-stabilized with a tenacity of not less than 60 cN/tex, from one of the following materials:

- a) Polyamide (PA), high tenacity multifilament;
- b) Polyester (PES), high tenacity multifilament;
- c) Polypropylene (PP), high tenacity multifilament.

**NOTE:**

- i) The definitions for these are given in ISO 2076. The content of the constituent materials may be determined in accordance with ISO 1833
- ii) Attention is drawn to the different resistance of man-made fibres to chemicals, which are summarized in annex B of Table A.1.

**4.2.2.4. Effective working length (EWL)**

4.2.2.4.1. The effective working length (EWL),  $L_1$ , of a fibre sling (see figure 2 & 3) shall not differ from the nominal length by more than 2 % of the nominal length, when laid flat and pulled taut by hand tension and measured with a steel tape or rule graduated in increments of 1 mm.

Issued by: Head of Section Tech Stds & Specs

Authorized by: Head of Department, R & D

Signed: 

Signed: 

Date: 2014-07-08

Date: 2014-07-08

4.2.2.4.2. The working load limits (WLL) of a sling assembly, for a given mode of assembly or use shall be derived from the WLL of the sling in straight lift multiplied by the appropriate mode factor, M, in accordance with Table 2. The assemblies and corresponding load limits shall be as per Fig. 2 & 3 and Table 2.

4.2.2.4.3. The colour of the cover shall be as given in Table 2 to indicate the WLL of the sling in straight lift. Fibre slings of any other nominal WLL's, not indicated in Table 2 shall not be denoted with the colours indicated therein.

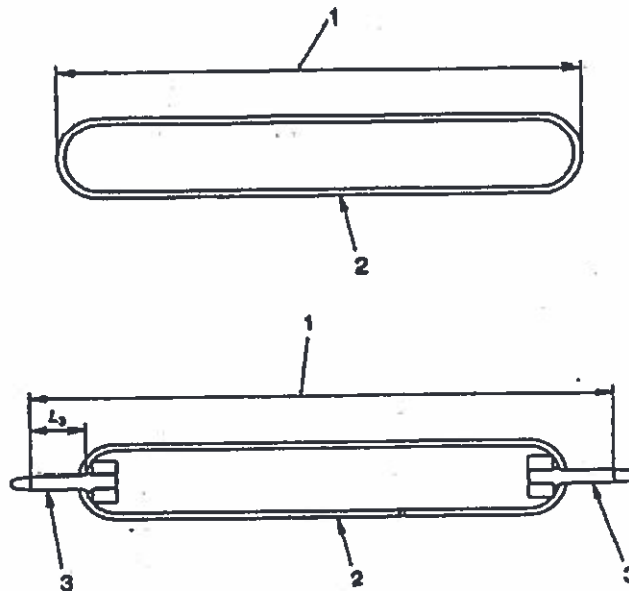

**Fig. 2: Effective working length**

Where:

- a) 1 - Effective working length ( $L_1$ )
- b) 2 - Round sling
- c) 3 - Integral fitting

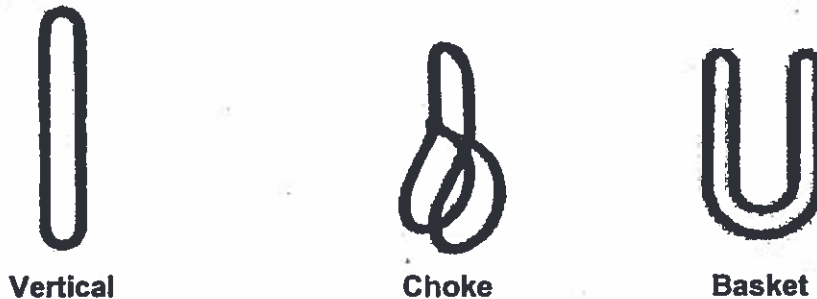

**Fig. 3: Type of hitches**

Issued by: Head of Section Tech Stds & Specs

Authorized by: Head of Department, R & D

Signed:

Signed:

Date: 2014-07-08

Date: 2014-07-08



**Table 2 — Working load limits and colour codes**

<b>Fibre slings manufactured to BS EN 1492-1 &amp; 2</b>				
<b>Colour of round sling cover</b>	<b>W.LL (Tons)</b>	<b>Vertical</b>	<b>Choke</b>	<b>Basket</b>
		<b>W. LL (Tons)</b>	<b>S.LL (Tons)</b>	<b>S.W.L (Tons)</b>
		<b>M = 1.0</b>	<b>M = 0.8</b>	<b>M = 2.0</b>
Violet	1.0	1.0	0.8	2.0
Green	2.0	2.0	1.6	4.0
Yellow	3.0	3.0	2.4	6.0
Grey	4.0	4.0	3.2	8.0
Red	5.0	5.0	4.0	10.0
Brown	6.0	6.0	4.8	12.0
Blue	8.0	8.0	6.4	16.0
Orange	10.0	10.0	8.0	20.0

M = Mode factor for symmetrical loading. Handling tolerance for slings or parts of slings indicated as vertical = 6°

4.2.2.4.4. The minimum failure force for the fibre sling core in straight pull shall be such that it will sustain a force equivalent to 7 times the WLL when the sling is tested in accordance with annex A of EN 1492-1 & 2: 2000, but during the test the cover shall not rupture at a force equivalent to less than 2 times the WLL. The sling shall not be preloaded prior to testing, unless all slings of the same type are subjected to identical pre-loading.

**4.2.2.5. Fittings supplied as part of a sling**

4.2.2.5.1. Fittings shall to be supplied with the slings and shall conform to the appropriate part or parts of EN 1677:2000 (for Parts 1 and 2) and of EN 1677:1998 (for Parts 3, 4, 5 and 6).

4.2.2.5.2. The seating of a fitting in contact with the sling shall be so finished as to allow the sling to adopt a natural (flattened) form under load and, when the sling is tested in accordance with annex A of EN 1492- 1 or 2: 2000:

- a) There shall be no damage to the area of the roundsling in contact with the fitting;
- b) The roundsling shall sustain the load.

**NOTE:** *Welded fittings shall be placed so that the welds remain visible when the sling is in use.*

Issued by: Head of Section Tech Stds & Specs

Authorized by: Head of Department, R & D

Signed: 

Signed: 

Date: 2014-07-08

Date: 2014-07-08



Kenya Power

TITLE:

**SPECIFICATION FOR  
OVERHEAD LINES  
LOAD HANDLING DEVICES**

Part 2: Sisal Ropes and Fibre  
Slings

Doc. No.

KP1/3CB/TSP/09/060-2

Issue No.

1

Revision No.

0

Date of Issue

2014-07-08

Page 10 of 26

**4.2.2.6. Protection against damage from edges and/or abrasion**

Protective sleeves, where provided, shall be of tubular form such that they are free to enable them to be positioned over the part of the roundsling which is to be protected.

**NOTE:** *Examples of suitable protective materials are webbing, woven fabric, leather or other durable material*

**4.2.2.7. Traceability code**

The traceability code, which is to be included in the marking (see 6.1), shall enable at least the following basic elements of the manufacturing record to be traced:

- a) Identification of the core and cover material;
- b) Identification of manufacturer's control;
- c) Identification and grade of fittings.

**4.2.3. Endless flexible roundsling**

4.2.3.1. The endless flexible sling shall be designed, manufactured and tested to EN 1492 Part 2:2000.

4.2.3.2. The core of the sling shall be formed from more yarns of high tenacity multifilament material conforming to clause 4.2.2.3; wound together with a minimum of 11 turns, and joined to form an endless hank.

4.2.3.3. It shall be uniformly wound to ensure even distribution of the load. Any additional joins in the yarns shall be separated by at least four turns of the yarn and shall be compensated for by an extra turn per join (See figure 3).

4.2.3.4. The cover shall be of webbing woven from the same material as the core, and made with the ends overlapped and sewn. The edges of the woven cover material shall be finished in such a way that they cannot unravel. If the cover is welded, care shall be taken to ensure that the welding does not affect the core.

**NOTE:** *The woven material of the cover shall be treated to produce a closed surface*

4.2.3.5. The thread of all seams shall be made of identical parent material (see A) as the cover and core, and the seam shall be made with a locking stitch machine.

**NOTE** *The use of a different colour thread to that of the cover will facilitate inspection during the manufacturer's verification and in-service inspections by the user.*

Issued by: Head of Section Tech Stds & Specs

Authorized by: Head of Department, R & D

Signed:

Signed:

Date: 2014-07-08

Date: 2014-07-08



Kenya Power

TITLE:

**SPECIFICATION FOR  
OVERHEAD LINES  
LOAD HANDLING DEVICES**

Part 2: Sisal Ropes and Fibre  
Slings

Doc. No.

KP1/3CB/TSP/09/060-2

Issue No.

1

Revision No.

0

Date of Issue

2014-07-08

Page 11 of 26

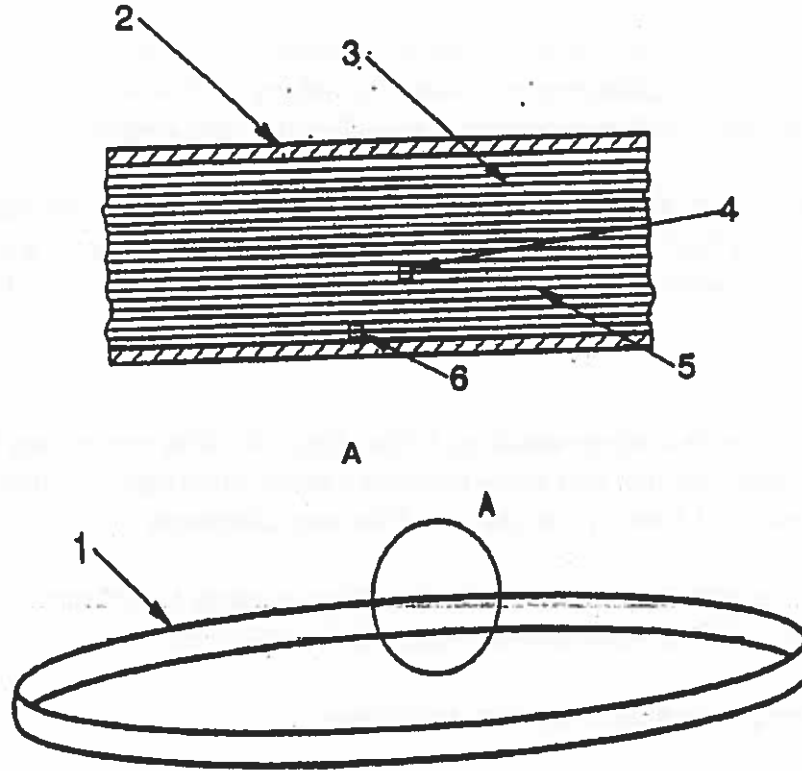

Where:

1. Round sling
2. Cover
3. Core yarns
4. Additional join
5. Minimum of four turns of yarn
6. Join forming endless hank

**Figure 3: Principle of core construction**

**4.2.4. Flat woven endless webbing sling**

**4.2.4.1. Design and construction**

The flat woven endless webbing sling design, shall be made from flat webbing fibre woven continuously from high tenacity material and shall meet the performance requirements of EN 1492 Part 1:2000 and shall have a minimum 7: 1 factor of safety.

Issued by: *[Signature]* Head of Section Tech Stds & Specs

Authorized by: Head of Department, R & D

Signed:

*[Signature]*

Signed:

*[Signature]*

Date: 2014-07-08

Date: 2014-07-08

Doc. No.	KP1/3CB/TSP/09/060-2
Issue No.	1
Revision No.	0
Date of Issue	2014-07-08
Page 12 of 26	

**4.2.4.2. Weaving**

4.2.4.2.1. Whether it is conventional or shuttleless woven, the webbing shall be woven with multiple piles, uniformly woven and the edges such that when one of the yarns breaks during weaving the ends cannot be pulled from the webbing causing it to unpick.

4.2.4.2.2. The method of weaving shall be such that the width of the finished sling changes by not more than -10 % for widths less than or equal to 100 mm, and -12% for widths over 100 mm, when a sample is tested in accordance with annex A of EN 1492 Part 1:2000.

**4.2.4.3. Width**

The width of the woven webbing,  $b$  (see figure 4), shall not be less than 25 mm and shall not exceed 450 mm and when measured with a steel tape or a rule graduated in increments of 1 mm, shall have the following tolerances:

- a)  $\pm 10 \%$  for nominal widths less than or equal to 100 mm;
- b)  $\pm 8 \%$  for nominal widths greater than 100 mm.

**4.2.4.4. Webbing thickness and sling thickness**

4.2.4.4.1. For single layer flat woven webbing slings, the loadbearing element of the sling shall have a minimum thickness of 2 mm exclusive of any finishes or cast-on features. For multi-layer slings, the webbing used to provide each layer of the loadbearing element of the sling shall have a minimum thickness of 1.2 mm.

4.2.4.4.2. The thickness,  $s_1$  (see figure 4), shall be measured in accordance with ISO 5084.

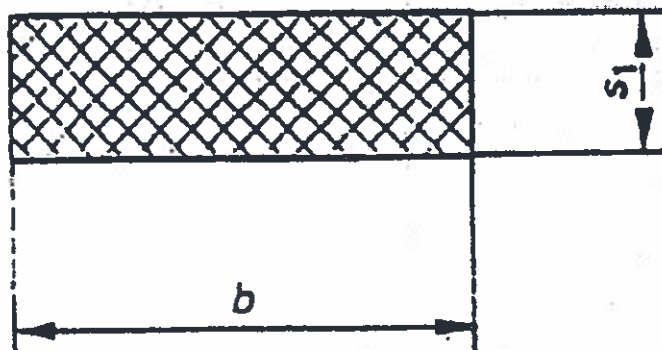

**Fig. 4: Webbing width and thickness**

Issued by: *[Signature]* Head of Section Tech Stds & Specs

Authorized by: Head of Department, R & D

Signed: *[Signature]*

Signed: *[Signature]*





Date: 2014-07-08

Date: 2014-07-08

**4.2.4.5. Sling types and designation**

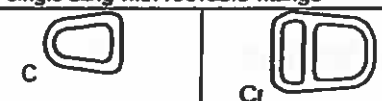
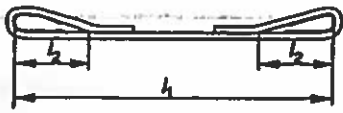
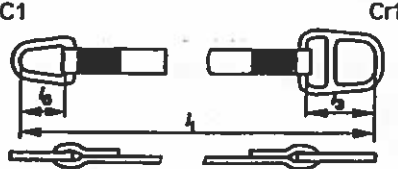
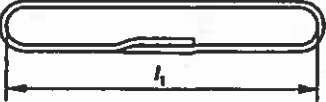
Endless flat woven webbing slings, type A, shall be made from 1 or 2 webbing layers. Single flat woven webbing slings with soft eyes, type B, and single flat woven webbing slings with metal fittings, type C, and/or reeveable fittings, type Cr, shall be made from 1, 2, 3 or 4 layers. The designation shall give the type letter and number of layers, e.g. A2 (see Table 3).

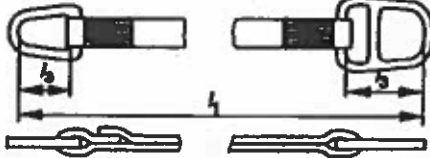
**Table 3: Summary and type designation of main types of flat woven webbing slings.**

Form	A - endless	B - single sling with reinforced eyes	C - single sling with fittings Cr - single sling with reeveable fittings
Load bearing webbing parts			
Single load bearing part		single layer sling with reinforced eyes B1 	single layer sling with fittings C1 Cr1 
Two load bearing parts	single layer sling A2 	two layer sling with reinforced eyes B2 	two layer sling with fittings C2 Cr2 
Four load bearing parts	two layer sling A4 		

**4.2.4.6. Soft eyes**

The inside length,  $l_2$ , of the eyes (see table 3), when measured flat using a steel tape or rule graduated in increments of 1 mm, shall be of the following minimum dimensions:

- a) Three times the width of the webbing for width of up to 150 mm;
- b) Two and a half times the width of the webbing for widths greater than 150 mm.

Issued by: Head of Section Tech Stds & Specs

Authorized by: Head of Department, R & D

Signed:



Signed:



Date: 2014-07-08

Date: 2014-07-08

**NOTE:** The preferred types of soft eye formation are illustrated in figure 4.

- a) Folded eyes are produced by folding the parts of the webbing that form the eye onto each other to narrow the profile of engagement. The two edges are sewn together or to the webbing itself.
- b) Folded eyes may also be reversed
- c) The eye types illustrated are not exhaustive.
- d) For reasons of clarity, eye reinforcement has been omitted from the illustrations, it is however a requirement of this specification that soft eyes are reinforced to protect the inner surface of the eye against damage during lifting and at the point of choking in a choked lift using a suitable reinforcing material such as a sleeve or piece of webbing or leather or other durable material.

1) Flat eye



2) Reversed eye



3) Folded eye 1/2 width from one side



4) Folded eye 1/2 width from two sides



5) Folded eye 1/3 width



**Fig. 4: Preferred soft eye types**

Issued by:  Head of Section Tech Stds & Specs

Authorized by: Head of Department, R & D

Signed:

Signed: 

Date: 2014-07-08

Date: 2014-07-08



Kenya Power

TITLE:

**SPECIFICATION FOR  
OVERHEAD LINES  
LOAD HANDLING DEVICES**

Part 2: Sisal Ropes and Fibre  
Slings

Doc. No.

KP1/3CB/TSP/09/060-2

Issue No.

1

Revision No.

0

Date of Issue

2014-07-08

Page 15 of 26

**4.2.4.7. Sewing of slings**

4.2.4.7.1. All seams shall be made from thread of identical parent material (see 4.2.2.3) as the webbing and shall be made with a locking stitch machine.

4.2.4.7.2. Stitches shall not touch or affect the edges of the webbing except those which secure the eye durability reinforcement.

**NOTE:** *The use of a different colour thread to that of the rest of the sling will facilitate inspection during the manufacturer's verification and in-service inspections by the user*

4.2.4.7.3. The stitches of the seam shall traverse the parts of the webbing to be sewn together, and the stitching shall lay flat and not have loops above the surface of the webbing.

4.2.4.7.4. The ends of cut webbing shall be treated in such a way (e.g. fused by heating) as to prevent unravelling. Treatment of cut ends by heating shall not damage adjacent stitching, and heat-treated ends shall not be over sewn.

**NOTE:** *Where the webbing has been impregnated to prevent thread slippage, further treatment is not necessary, in which case the ends may be oversewn.*

**4.3. Quality Management System**

4.3.1. The supplier shall submit a quality assurance plan (QAP) that will be used to ensure that the design, material, workmanship, tests, service capability, maintenance and documentation of the sisal ropes and fibre slings fulfil the requirements stated in the contract documents, standards, specifications and regulations. The QAP shall be based on and include relevant parts to fulfil the requirements of ISO 9001:2008.

4.3.2. The Manufacturer's Declaration of Conformity to applicable standards and copies of quality management certifications including copy of valid and relevant ISO 9001: 2008 certificate shall be submitted with the tender for evaluation.

4.3.3. The bidder shall indicate the delivery time of the sisal ropes and fibre slings, manufacturer's monthly & annual production capacity and experience in the production of the type and size of items being offered.

**5.0. TESTS AND INSPECTION**

5.1. The sisal ropes and fibre slings shall be inspected and tested in accordance with the requirements of EN 1492-1 & 2, ISO 9554, ISO 2307, ISO 1140, EN 1677 and ISO 5084 standards and all the provisions of this specification. It shall be the responsibility of the

Issued by: Head of Section Tech Stds & Specs

Authorized by: Head of Department, R & D

Signed:

Signed:

Date: 2014-07-08

Date: 2014-07-08



Kenya Power

TITLE:

**SPECIFICATION FOR  
OVERHEAD LINES  
LOAD HANDLING DEVICES**

Part 2: Sisal Ropes and Fibre  
Slings

Doc. No.

KP1/3CB/TSP/09/060-2

Issue No.

1

Revision No.

0

Date of Issue

2014-07-08

Page 16 of 26

supplier to perform or to have performed the tests specified and whatever other tests he normally performs at works.

- 5.2. Copies of previous Type Tests Reports issued by a third party testing laboratory that is accredited to ISO/IEC 17025 shall be submitted with the tender for the purpose of technical evaluation. The accreditation certificate to ISO/IEC 17025 for the same third party testing laboratory used shall also be submitted with the tender document (all in English Language)
- 5.3. The sisal ropes and fibre slings shall be subject to acceptance tests at the manufacturer's works before dispatch. Acceptance tests shall be witnessed by two Engineers appointed by The Kenya Power and Lighting Company Limited (KPLC). Routine and Sample Test Reports for the sisal ropes and fibre slings to be supplied shall be submitted to KPLC for approval before delivery of the goods.
- 5.4. On receipt of the product, KPLC will perform any of the tests specified in order to verify compliance with this specification. The supplier shall replace without charge to KPLC the sisal ropes and fibre slings which upon examination, test or use; fail to meet any of the requirements in the specification.

**6.0. MARKING, PACKING AND LABELLING**

**6.1. MARKINGS**

- 6.1.1. The identification of the material, quality and origin of a sisal rope shall be marked using a tape placed within the article (see 6.1.2 a & b) so as to remain recognizable despite soiling, soaking or discoloration during use.
- 6.1.2. The tape shall be at least 3 mm wide, and shall be printed with the number of the relevant ISO International Standard, and a reference identifying the manufacturer. The maximum distance between two consecutive markings shall be 0.5 m.
  - a) Ropes of reference number less than 14  
These do not need to be marked unless specified in a product standard.
  - b) Ropes of reference number equal to or greater than 14  
A marker tape as defined in 6.1.1 shall be incorporated into the centre of one strand for 3-, 4-, 8- and 12- strand ropes. Double braided ropes shall have a marker tape in or outside the core.

6.1.3. The marking of the endless fibre slings shall include the following:

- a) The working load limit, in straight pull;

Issued by:  Head of Section Tech Stds & Specs

Authorized by: Head of Department, R & D

Signed:



Signed:



Date: 2014-07-08

Date: 2014-07-08





Kenya Power

TITLE:

**SPECIFICATION FOR  
OVERHEAD LINES  
LOAD HANDLING DEVICES**

Part 2: Sisal Ropes and Fibre  
Slings

Doc. No.	KP1/3CB/TSP/09/060-2
Issue No.	1
Revision No.	0
Date of Issue	2014-07-08
Page 17 of 26	

- b) The material of the roundsling, i.e. polyester, polyamide, polypropylene;
- c) Grade of fitting;
- d) The nominal length in m;
- e) The manufacturer's name, symbol, trade mark or other unambiguous identification and, where applicable, the name and address of the authorized representative";
- f) The traceability code (see 4.2.2.7);
- g) The number and relevant Part of this European Standard.

6.1.4. Marking for multi-leg sling assemblies

The following requirements shall apply to 2 leg, 3 leg or 4 leg sling assemblies:

- a) The marking shall be on a readily-identifiable form of durable label (e.g. around tag) which shall be attached to the master link to differentiate from other sling types;
- b) The marking of the sling assembly shall include the maximum angle of use of any leg to the vertical;
- c) The label on each leg shall not show the WLL.

**NOTE:** *Marking this European Standard number on or in relation to a product represents a manufacturer's declaration of conformity, i.e. a claim by or on behalf of the manufacturer that the product meets the requirements of the standard. Such a declaration is not to be confused with third-party certification of conformity.*

6.2. PACKAGING

6.2.1. Sisal Rope:

- a) The packaging unit shall be a reel, a coil, a hank, a box, a bag, a bulk or as specified by the purchaser.
- b) The finished rope shall be supplied in a package so that it can be dispensed freely without entanglement of any kind.
- c) Either the unit mass or the length invoices the rope. When gross mass is used for invoicing, the mass of the packaging shall not exceed 1.5 % of the gross mass of the rope.

6.2.2. Fibre Slings

The packaging unit shall be a box, a bag, a bulk or as specified by the purchaser. It shall be dry, clean, free from contaminates and shaded from direct sunlight.

6.2.3. The following information shall be printed on a suitable label firmly attached to each packaging:

Issued by: Head of Section Tech Stds & Specs

Authorized by: Head of Department, R & D

Signed:

Signed:

Date: 2014-07-08

Date: 2014-07-08



Kenya Power

TITLE:

**SPECIFICATION FOR  
OVERHEAD LINES  
LOAD HANDLING DEVICES**

Part 2: Sisal Ropes and Fibre  
Slings

Doc. No.

KP1/3CB/TSP/09/060-2

Issue No.

1

Revision No.

0

Date of Issue

2014-07-08

Page 18 of 26

- a) Purchase order number/tender
- b) Manufacturer's name
- c) Year of manufacture
- d) Insulated hand tools catalog number
- e) The words, "PROPERTY OF KENYA POWER & LIGHTING CO.

**6.3. LABELLING**

6.3.1. Labelling of the fibre slings shall be as per Fig 5 in accordance with EN 1492.

**NOTE:**

- a) The reverse side of the exposed part of the label may additionally be marked with the WLLs of the sling in various modes of use (see Figure 3 b))
- b) The material from which the webbing is made shall be identified by the colour of the label itself on which the information is marked. The following label colours shall be used:
  - i) Polyamide green
  - ii) Polyester blue
  - iii) Polypropylene brown
- c) The information shall be marked (in accordance with 6.1) both legibly and indelibly, on a durable label fixed directly onto the sling. It shall be marked in a type size of not less than 1.5 mm in height. A section of the label shall be stitched under the cover which shall also be marked with this information for reference purposes. A typical label is shown in figure 3 and figure 4 shows the typical methods of attachment of the label.

6.3.2. For sisal ropes, each coil shall have a label, which is firmly fixed in place, giving the following information:

- a) Constituent material;
- b) Identification of manufacturer and country of origin;
- c) Reference number;
- d) Delivered length in accordance with clause 7.2 of ISO 9554 ;
- e) Declaration of conformity to this International Standard relating to the constituent material (e.g. "according to ISO 9554").

Issued by: Head of Section Tech Stds & Specs

Authorized by: Head of Department, R & D

Signed:

Signed:

Date: 2014-07-08

Date: 2014-07-08

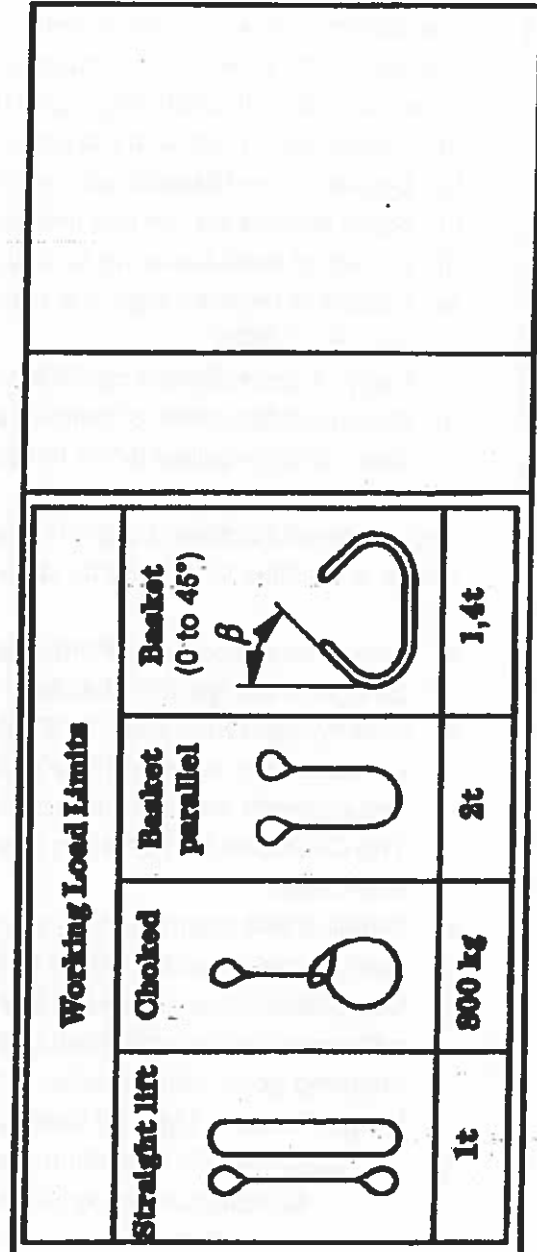
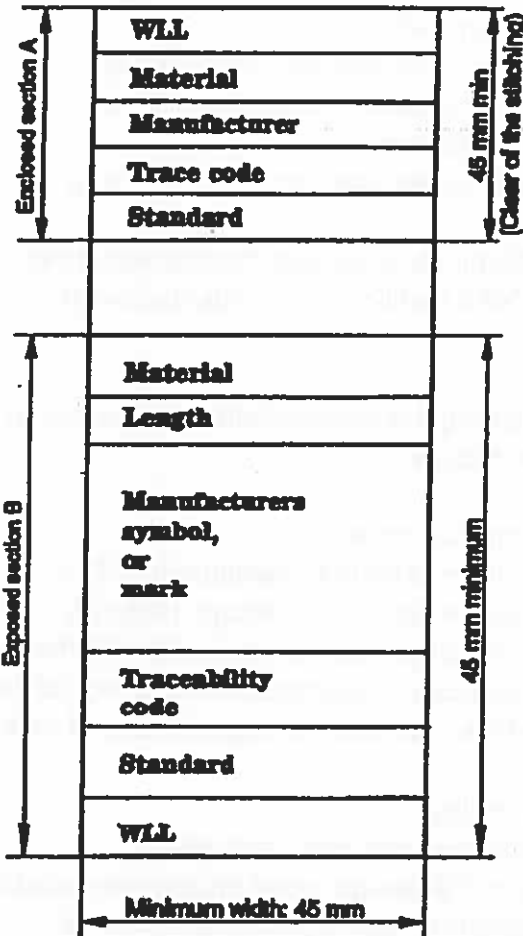

AC a) Front AC

AC b) Reverse (optional) AC

**Fig. 5: Typical label format for slings**

Issued by: Head of Section Tech Stds & Specs

Authorized by: Head of Department, R & D

Signed:

Signed:

Date: 2014-07-08

Date: 2014-07-08



Kenya Power

TITLE:

**SPECIFICATION FOR  
OVERHEAD LINES  
LOAD HANDLING DEVICES**

Part 2: Sisal Ropes and Fibre  
Slings

Doc. No.

KP1/3CB/TSP/09/060-2

Issue No.

1

Revision No.

0

Date of Issue

2014-07-08

Page 20 of 26

**7. DOCUMENTATION**

7.1 The bidder shall submit its tender complete with technical documents required by Annex A (Guaranteed Technical Particulars) for tender evaluation. The technical documents to be submitted (all in English language) for tender evaluation shall include the following:

- a) Guaranteed Technical Particulars signed by the manufacturer;
- b) Copies of the Manufacturer's catalogues, brochures, drawings and technical data;
- c) Sales records for the last five years and at least four customer reference letters;
- d) Details of manufacturing capacity and the manufacturer's experience;
- e) Copies of required type test reports by a third party testing laboratory accredited to ISO/IEC 17025;
- f) Copy of accreditation certificate to ISO/IEC 17025 for the third party testing laboratory;
- g) Manufacturers letter of authorization, ISO 9001:2008 certificate and other technical documents required in the tender.

7.2 The successful bidder (supplier) shall submit the following documents/details to The Kenya Power & Lighting Company for approval before manufacture:

- a) Guaranteed Technical Particulars signed by the manufacturer;
- b) Design Drawings with details of sisal ropes and slings to be manufactured for KPLC.
- c) Quality assurance plan (QAP) that will be used to ensure that the design, material; workmanship, tests, service capability, maintenance and documentation will fulfill the requirements stated in the contract documents, standards, specifications and regulations. The QAP shall be based on and include relevant parts to fulfill the requirements of ISO 9001:2008
- d) Detailed test program to be used during factory testing;
- e) Marking details and method to be used in marking the sisal ropes and slings;
- f) Manufacturer's undertaking to ensure adequacy of the design, good engineering practice, adherence to the specification and applicable standards and regulations as well as ensuring good workmanship in the manufacture of the sisal ropes and slings for The Kenya Power & Lighting Company;
- g) Packaging details (including packaging materials) including but not limited to:
  - i) Manufacturer's certificate  
After all testing and examination, as specified in clause 6, the manufacturer shall issue to the purchaser, for each batch of slings and ropes delivered, a certificate which shall include at least the following information:
    - The manufacturer's name and address, symbol or mark **A1** and, where applicable, the name and address of the authorized representative **A1**;

Issued by: Head of Section Tech Stds & Specs

Authorized by: Head of Department, R & D

Signed:

Signed:

Date: 2014-07-08

Date: 2014-07-08



Kenya Power

TITLE:

**SPECIFICATION FOR  
OVERHEAD LINES  
LOAD HANDLING DEVICES**

Part 2: Sisal Ropes and Fibre  
Slings

Doc. No.

KP1/3CB/TSP/09/060-2

Issue No.

1

Revision No.

0

Date of Issue

2014-07-08

Page 21 of 26

- WLL of the sling and for multi-leg sling assemblies the range of angles to the vertical;
- Type, including fitting, number of legs and nominal length;
- The expression 'roundsling' or 'roundsling assembly';
- Material of the sling;
- Grade of fitting;
- If fitted, details of protective sleeves;
- The number of this European Standard, i.e. EN 1492-2;
- Test references (see clause 6);
- Traceability code;
- Identity of the person authorized to sign the certificate on behalf of the manufacturer and date of signature;
- **A1** The static test coefficient(s) used for design of component(s) (e.g. hooks; link; shackle). **A1**

ii) Instructions for use

Instructions for use shall accompany each sling or each delivery of slings supplied against a single order and shall conform to annex B of EN 1492.

7.3 The supplier shall submit recommendations for use, care, storage and routine inspection/testing procedures, all in the English Language, during delivery of the sisal ropes and slings to KPLC stores.

-----SPACE LEFT BLANK-----

Issued by: Head of Section Tech Stds & Specs

Authorized by: Head of Department, R & D

Signed:

Signed:

Date: 2014-07-08

Date: 2014-07-08



**Kenya Power**

**TITLE:**

**SPECIFICATION FOR  
OVERHEAD LINES  
LOAD HANDLING DEVICES**

**Part 2: Sisal Ropes and Fibre  
Slings**

**Doc. No.**

**KP1/3CB/TSP/09/060-2**

**Issue No.**

**1**

**Revision No.**

**0**

**Date of Issue**

**2014-07-08**

Page 22 of 26

**ANNEX A: Guaranteed Technical Particulars (to be filled and signed by the Supplier and submitted together with copies of manufacturer's catalogues, brochures, drawings, technical data, sales records, customer reference letters and copies of certificates/test reports for tender evaluation)**

**Tender No. ....**

Clause number	Bidder's offer (indicate full details of the offered item for each requirement of the tender & specification)
Bidder's Name	
Manufacturer's Name, address and country	
Type reference/model number of item(s) offered	
Scope: 1.1	
1.2 Load Handling Accessories	
a) Sisal Ropes	
b)	
c) Fibre Sling	
• Endless flexible roundsling	
• Flat woven endless webbing sling	
1.4-15	
2.0 Applicable Standards (References)	
3.0 Terms & definitions	
4.0 Requirements	
4.1 Service conditions	
4.2 Particular requirements	
4.2.1 Sisal ropes	
4.2.1.1 Construction and structure	
4.2.1.1.1 - 4.2.1.1.4.	
4.2.1.2 Treatment	
4.2.1.2.1 - 4.2.1.2.3	
4.2.1.3 Workmanship	
4.2.1.3.1 - 4.2.1.3.2	
4.2.1.4 Lay length or pitch length	
4.2.1.5 Ratings	
4.2.1.5.1 - 4.2.1.5.2	
4.2.1.6 Required sizes	
4.2.2 Fibre Slings	
4.2.2.1 General	

Issued by:  Head of Section Tech Stds & Specs

Authorized by: Head of Department, R & D

Signed:



Signed:



Date: 2014-07-08

Date: 2014-07-08



Kenya Power

TITLE:

**SPECIFICATION FOR  
OVERHEAD LINES  
LOAD HANDLING DEVICES**

Part 2: Sisal Ropes and Fibre  
Slings

Doc. No.

KP1/3CB/TSP/09/060-2

Issue No.

1

Revision No.

0

Date of Issue

2014-07-08

Page 23 of 26

4.2.2.2 Design and construction	
4.2.2.2.1 - 4.2.2.2.2	
4.2.2.3 Material requirements	
4.2.2.4 Effective working length (EWL)	
4.2.2.4.1 - 4.2.2.4.4	
4.2.2.5 Fittings supplied as part of slings	
4.2.2.5.1 - 4.2.2.5.2	
4.2.2.6 Protection against damage from edges or abrasion	
4.2.2.7 Traceability code	
4.2.3 Endless flexible roundsling	
4.2.3.1 - 4.2.3.5	
4.2.4 Flat woven endless webbing sling	
4.2.4.1 Design and construction	
4.2.4.2 Weaving	
4.2.4.2.1- 4.2.4.2.2	
4.2.4.3 Width	
4.2.4.4 Webbing thickness and sling thickness	
4.2.4.4.1- 4.2.4.4.2	
4.2.4.5 Sling types and designation	
4.2.4.6 Soft eyes	
4.2.4.7 Sewing of slings	
4.3 Quality Management System	
5.0 Tests and Inspection	
5.1 - 5.4	
6.0 Marking, Packing and Labeling	
6.1 Marking	
6.1.1 - 6.1.4	
6.2 Packing	
6.2.1 Sisal rope	
6.2.2 Fibre Slings	
6.3 Labeling	
6.3.1 - 6.3.3	
7.0 Documentation	
7.1 Completed tender document	
7.2 Catalogues, brochures, drawings & technical data submitted with offer	
8.0. Manufacturer's Guarantee and Warranty	

Issued by: Head of Section Tech Stds & Specs

Authorized by: Head of Department, R & D

Signed:

Signed:

Date: 2014-07-08

Date: 2014-07-08



Kenya Power

TITLE:

**SPECIFICATION FOR  
OVERHEAD LINES  
LOAD HANDLING DEVICES**

Part 2: Sisal Ropes and Fibre  
Slings

Doc. No.

KP1/3CB/TSP/09/060-2

Issue No.

1

Revision No.

0

Date of Issue



2014-07-08

Page 24 of 26

9.0 List catalogues, brochures, technical data and drawings submitted to support the offer.	
10.0 List customer sales records and reference letters submitted to support the offer.	
11.0 List Test Certificates submitted with tender	
12.0 List test reports of cable guards to be submitted to KPLC for approval before shipment	
13.0 Statement of compliance to specification (indicate deviations if any & supporting documents)	

.....  
Supplier's Name, Signature, Stamp and Date

-----PAGE LEFT BLANK-----

Issued by: Head of Section Tech Stds & Specs	Authorized by: Head of Department, R & D
Signed: 	Signed: 
Date: 2014-07-08	Date: 2014-07-08