



**SPECIFICATION FOR EARTH  
RODS AND THEIR  
CONNECTORS**

Part 1: Copper Clad Earth Rods  
and their connectors

Doc. No.	KP1/3CB/TSP/06/031-1
Issue No.	3
Revision No.	0
Date of Issue	2014-04-06
Page 1 of 19	

**TABLE OF CONTENTS**

**0.1 Circulation List**

**0.2 Amendment Record**

**FOREWORD**

- 1. SCOPE**
- 2. REFERENCES**
- 3. TERMS AND DEFINITIONS**
- 4. REQUIREMENTS**
- 5. TESTS AND INSPECTION**
- 6. PACKING, MARKING AND INSTRUCTIONS**

**ANNEX A:** **Guaranteed Technical Particulars** (to be filled and signed by the Manufacturer and submitted together with relevant copies of the Manufacturer's catalogues, brochures, drawings, technical data, sales records for previous five years, four customer reference letters, details of manufacturing capacity, the manufacturer's experience and copies of complete type test certificates and type test reports for tender evaluation, all in English Language)

Issued by: Head of Section, Technical Standards  
and Specifications

Authorized by: Head of Department, R&D

Signed:

Signed:

Date: 2014/04/06

Date: 2014/04/06



**SPECIFICATION FOR EARTH  
RODS AND THEIR  
CONNECTORS**

Part 1: Copper Clad Earth Rods  
and their connectors

Doc. No.	KP1/3CB/TSP/06/031-1
Issue No.	3
Revision No.	0
Date of Issue	2014-04-06
Page 2 of 19	

**0.1 Circulation List**

COPY NO.	COPY HOLDER
1	Research & Development Manager
2	Supply Chain Manager (Procurement)
Electronic copy (pdf) on Kenya Power server: ( <a href="http://172.16.1.40/dms/browse.php?ffolderid=23">http://172.16.1.40/dms/browse.php?ffolderid=23</a> )	

**0.2 Amendment Record**

Rev No.	Date (YYYY-MM-DD)	Description of Change	Prepared by (Name & Signature)	Approved by (Name & Signature)
0	2014-04-06	Cancel and replaces issue No. 2 dated 2013/05/13	Michael Apudo 	George Owuor 

Issued by: Head of Section, Technical Standards and Specifications

Signed:

Date: 2014/04/06

Authorized by: Head of Department, R&D

Signed:

Date: 2014/04/06



## SPECIFICATION FOR EARTH RODS AND THEIR CONNECTORS

Part 1: Copper Clad Earth Rods and their connectors

Doc. No.	KP1/3CB/TSP/06/031-1
Issue No.	3
Revision No.	0
Date of Issue	2014-04-06
Page 3 of 19	

### FOREWORD

This specification has been prepared by the Research and Development Department of The Kenya Power and Lighting Company Limited (abbreviated as KPLC). It lays down requirements for Copper Clad Earth Rods and their connectors for use in Kenya Power distribution network and substation earthing. It is intended for use by KPLC in purchasing the items.

This specification supersedes all specifications for earth rods issued before the revision date. The specification for earth rods and their connectors is issued in parts as follows:

- Part 1: Copper Clad Earth Rods and their connectors
- Part 2: Stainless Steel Earth Rods and their connectors
- Part 3: Galvanized Steel Earth Rod and their connectors

### 1. SCOPE

- 1.1. This specification is for copper-clad earth rods and the associated connectors. It covers only extensible copper-clad earth rods and connectors which constitute the following items:
- a) Copper clad earth rod
  - b) Connectors which include:
    - (i) Couplings,
    - (ii) Driving head,
    - (iii) Bull-dog grip clamp.

NOTE: The required quantities of the items shall be stated in the tender.

- 1.2. The specification stipulates the minimum requirements for copper-clad earth rods and the associated connectors acceptable for use in the company and it shall be the responsibility of the supplier to ensure adequacy of the design, good engineering practice, adherence to the specification and applicable standards and regulations as well as ensuring good workmanship in the manufacture of the items for The Kenya Power & Lighting Company.
- 1.3. The specification does not purport to include all the necessary provisions of a contract.

### 2. REFERENCES

The following standards contain provisions which, through reference in this text constitute provisions of this specification. Unless otherwise stated, the latest editions (including amendments) apply.

Issued by: Head of Section, Technical Standards and Specifications

Authorized by: Head of Department, R&D

Signed:

Signed:

Date: 2014/04/06

Date: 2014/04/06



**SPECIFICATION FOR EARTH RODS AND THEIR CONNECTORS**

Part 1: Copper Clad Earth Rods and their connectors

Doc. No.	KP1/3CB/TSP/06/031-1
Issue No.	3
Revision No.	0
Date of Issue	2014-04-06
Page 4 of 19	

- ISO 2859-1: Sampling procedures for inspection by attributes — Part 1: Sampling schemes indexed by acceptance quality limit (AQL) for lot-by-lot inspection
- ISO 9001: Quality management systems -- Requirements
- BS 7430: Code of practice for protective earthing of electrical installations
- BS PD 970: Wrought steels for mechanical and allied engineering purposes. Requirements for carbon, carbon manganese and alloy hot worked or cold finished steel
- BS 2874: Specification for copper and copper alloy rods and sections (other than forging stock)
- BS EN 12163: Copper and copper alloys. Rod for general purposes
- BS 4168-1: Hexagon socket screws and wrench keys: metric series Specification for hexagon socket head cap screws
- BS 3643-2: ISO metric screw threads — Part 2: Specification for selected limits of size.
- UL 1439: Tests for Sharpness of Edges on Equipment
- KS 04 – 744: Specification for earth rods and their connectors. Part 1: Copper clad earth rods

**3. DEFINITIONS**

For the purpose of this specification, the definitions given in the reference standards shall apply.

**4. REQUIREMENTS**

**4.1. Service Conditions**

4.1.1. The copper-clad earth rods and associated connectors shall be suitable for installation in tropical areas at

- (i) Altitudes of up to 2200m above sea level,
- (ii) Humidity of up to 90%,

Issued by: Head of Section, Technical Standards and Specifications

Signed:

Date: 2014/04/06

Authorized by: Head of Department, R&D

Signed:

Date: 2014/04/06



## SPECIFICATION FOR EARTH RODS AND THEIR CONNECTORS

Part 1: Copper Clad Earth Rods and their connectors

Doc. No.	KP1/3CB/TSP/06/031-1
Issue No.	3
Revision No.	0
Date of Issue	2014-04-06
Page 5 of 19	

- (iii) Ambient temperatures of  $-1^{\circ}\text{C}$  to  $+40^{\circ}\text{C}$ , average ambient temperature is  $30^{\circ}\text{C}$ . and
- (iv) A wide range of soils.

4.1.2. All components shall be manufactured from metal or metals such that when installed under conditions of actual service and exposed to moisture shall not be adversely affected by electrolysis or galvanic corrosion.

### 4.2. Design and Construction

#### 4.2.1. General

- 4.2.1.1. To ensure compatibility of component parts of the earth rod and connectors, the items to be supplied under this specification consist of copper-clad earth rod, coupling, driving head and bull dog clamp which form a "total system" conforming to BS 7430: 2011 standard requirements. This will include an assessment of the safety, reliability and long term performance of the items tendered.
- 4.2.1.2. The design of the earth rod assembly (including couplings, driving head and bull dog clamp) shall be of such mechanical strength that they shall withstand the stresses and abrasions present during installation with either electric/pneumatic hammer or direct hammering.
- 4.2.1.3. The design of the rods and couplings shall be such that during installation, the connection between the rod and the coupling shall "self-tighten". This self-tightening effect shall improve the electrical and mechanical performances of the rod/coupling combination. The Tenderer shall state the design features of the rod and accessories which verify the following features:
  - Self-tightening;
  - Improved electrical connection; AND
  - No damage to the copper sheath on installation.
- 4.2.1.4. The rod system shall be extendable by the use of appropriate couplings. All items including rods, couplings, driving points and clamps shall be clean, free of burrs, cracks and sharp edges.
- 4.2.1.5. Tenderers shall provide the recommended procedure for the correct assembly of the various components of the earthing system including the earth rod, coupling, driving head and clamps.

Issued by: Head of Section, Technical Standards and Specifications

Signed:

Date: 2014/04/06

Authorized by: Head of Department, R&D

Signed:

Date: 2014/04/06

**SPECIFICATION FOR EARTH  
RODS AND THEIR  
CONNECTORS**

Part 1: Copper Clad Earth Rods  
and their connectors

Doc. No.	KP1/3CB/TSP/06/031-1
Issue No.	3
Revision No.	0
Date of Issue	2014-04-06
Page 6 of 19	

**4.2.2. Threading**

- 4.2.2.1. Threads on the earth rods, couplings and hardware assembly (bull dog clamp bolts and driving heads) shall be formed by roll process ("roll thread" type) giving extra strength to the threads and eliminating the risk of chipping of threads while driving the ground rod in the ground.
- 4.2.2.2. The earth rods, bull dog clamp bolts and driving heads shall be externally threaded and matched with couplers and bull dog clamp nuts which shall be internally threaded and shall conform to each end of the rod electrode as per Fig. 1 and Table 1.
- 4.2.2.3. The threading system shall be to BS 3643 for ISO metric screw threads; class 3 (high accuracy, fine fits), with external thread designation of 4h for earth rods and internal thread designation of 5H for couplings as per Table 1; bolts and nuts thread tolerance class shall be standard (general assembly) of 6h and 6g respectively conforming to the values in Table 1 of BS 3643-2.

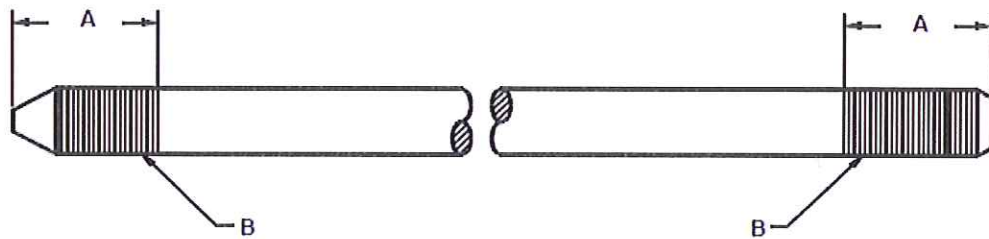

**Fig. 1: Threading dimensions**

**Table 1: Thread dimensions as per BS 3643-2**

Nominal diameter, mm		12.5	16	20	25	
Pitch		1.5	1.0	1.0	1.0	
Thread "A" length, mm	min	27.000	30	32	45	
	tol.	-1.6; + 3.2				
External threads of the rod; "B"	Tolerance class		4h			
	Fundamental deviation		0.032			0
	Major diameter, mm	max	12.500	16.000	20.000	25.000
		tol.	0.112			
	Pitch diameter, mm	min	12.388	15.888	19.888	24.888
		max	11.850	15.350	19.350	24.350
	Pitch diameter, mm	tol.	0.075			0.080
		min	11.775	15.275	19.275	24.270
Minor diameter, mm	min	11.159	14.659	18.659	23.654	

Issued by: Head of Section, Technical Standards and Specifications

Signed: 

Date: 2014/04/06

Authorized by: Head of Department, R&D

Signed: 

Date: 2014/04/06



**SPECIFICATION FOR EARTH  
RODS AND THEIR  
CONNECTORS**

Part 1: Copper Clad Earth Rods  
and their connectors

Doc. No.	KP1/3CB/TSP/06/031-1
Issue No.	3
Revision No.	0
Date of Issue	2014-04-06
Page 7 of 19	

Nominal diameter, mm		12.5	16	20	25	
Internal threads of the couplers	Tolerance class	5H				
	Fundamental deviation	0				
	Major diameter, mm	min	12.500	16.000	20.000	25.000
		max	11.975	15.475	19.475	24.482
	Pitch diameter, mm	tol.	0.125			0.132
		min	11.850	15.350	19.350	24.350
		max	11.607	15.107	19.107	24.107
	Minor diameter, mm	tol.	0.190			
		min	11.417	14.917	18.917	23.917

**4.3. Specific requirements**

**4.3.1. Copper-Clad Rods**

- 4.3.1.1. The copper clad earth rod shall be manufactured from a steel rod reference symbol P of a grade with tensile strength of 550 MPa to 700 MPa in accordance with BS PD 970: 2005 standard requirements; a Brinell hardness shall be 248 to 302 HBW as recommended by BS 7430:2011 standard.
- 4.3.1.2. An earth electrode shall be designed to have a loading capacity adequate for the system of which it forms a part, i.e. it shall be capable of dissipating the electrical energy in the earth path at the point at which it is installed under any condition of operation on the system.
- 4.3.1.3. Copper-clad steel earth rods shall be made by molecularly bonding 99.9% pure copper onto the high carbon, low tensile steel rods to achieve a minimum copper thickness of 0.254 mm (254 µm). The application of the copper sheath shall prevent any electrolytic action to be initiated by moisture ingress between the copper and the steel.
- 4.3.1.4. Tenderers shall state the method used to apply the copper sheath to the rod together with the design features to verify the prevention of moisture ingress.
- 4.3.1.5. To prevent oxidation of copper bonding, each rod shall be treated with Benzol Triazole derivatives. A proof of the same shall be provided by the tenderer.
- 4.3.1.6. Both ends of the rods shall be tapered as per Figure 2. The taper shall be approximately 3:100 on diameter and the minimum dimensions of the taper shall be as per Table 2 (as measured parallel to the axis of the earth rod).

Issued by: Head of Section, Technical Standards and Specifications

Authorized by: Head of Department, R&D

Signed:

Signed:

Date: 2014/04/06

Date: 2014/04/06

**SPECIFICATION FOR EARTH RODS AND THEIR CONNECTORS**

Part 1: Copper Clad Earth Rods and their connectors

Doc. No.	KP1/3CB/TSP/06/031-1
Issue No.	3
Revision No.	0
Date of Issue	2014-04-06
Page 8 of 19	

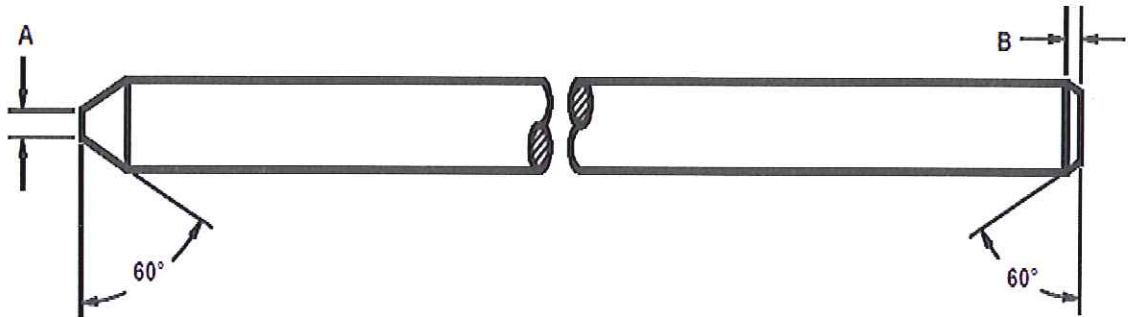

**Fig. 2: Earth rod**

**Table 2: Table of taper lengths**

Nominal diameter, mm	Point end "A" (mm)	Chamfer end "B" (mm)
12.5	4.70	2.40
16	4.70	3.20
20	6.35	3.20
25	9.50	5.55

4.3.1.7. The finished product shall have the following sizes as per KS 04 – 744 and Table 3 :

**Table 3: Earth rod sizes**

Nominal size		Rod length	
mm	Inches*	mm	Feet*
12.5	½ "	1,200	4'
16.0	5/8"	1,500	5'
20.0	¾ "	2,100	7'
25.0	1"	3,000	12'

\* The imperial sizes have been replaced by the metric sizes in this specification for clarity.

**4.3.2. Connectors**

**4.3.2.1. Couplings**

4.3.2.1.1. The couplings shall be manufactured from phosphor bronze, grade C102 or equivalent in accordance with BS 2874 and shall be suitable for direct burial.

Issued by: Head of Section, Technical Standards and Specifications

Signed:



Date: 2014/04/06

Authorized by: Head of Department, R&D

Signed:

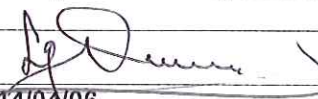

Date: 2014/04/06



**SPECIFICATION FOR EARTH RODS AND THEIR CONNECTORS**

Part 1: Copper Clad Earth Rods and their connectors

Doc. No.	KP1/3CB/TSP/06/031-1
Issue No.	3
Revision No.	0
Date of Issue	2014-04-06
Page 9 of 19	

- 4.3.2.1.2. The coupling shall be a threaded joining device which joins two earth rods together for extending earth rods in an earthing system. The threading system shall be as per clause 4.2.2, Table 1.
- 4.3.2.1.3. The coupling device shall be designed to ensure that a good permanent electrical conductivity is maintained between the joined earth rods throughout a service life of 35 years for the installed earth rod assembly.
- 4.3.2.1.4. The couplings in the assembled mode shall exhibit no less than 95% of the conductivity of an unspliced ground rod of equal length.
- 4.3.2.1.5. The material used shall be selected to ensure that electrolytic action and/or stress corrosion cracking will not occur. In addition, the surfaces of the couplings exposed to the soil, shall be corrosion resistant.
- 4.3.2.1.6. The couplings design shall be hexagonal in shape as per Fig. 3. The thickness shall be at least 3 mm and lengths of 50, 60 and 70 mm to suit the sizes of the earth rods as per Table 4. Tenderers shall state the material(s) used.

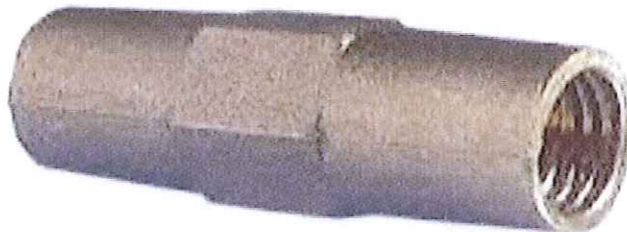

**Fig. 3: Hexagonal shape coupling**

**Table 4: Standard coupling sizes**

Nominal size		Coupling length
mm*	Inches	mm
12.5	½ "	50
16.0	5/8"	50
20.0	¾ "	60
25.0	1"	70
* Only the metric system shall be used at tender		

Issued by: Head of Section, Technical Standards and Specifications

Authorized by: Head of Department, R&D

Signed:



Signed:

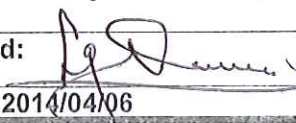

Date: 2014/04/06

Date: 2014/04/06

**SPECIFICATION FOR EARTH  
RODS AND THEIR  
CONNECTORS**

Part 1: Copper Clad Earth Rods  
and their connectors

Doc. No. KP1/3CB/TSP/06/031-1

Issue No. 3

Revision  
No. 0

Date of  
Issue 2014-04-06

Page 10 of 19

**4.3.2.2. Driving Head**

- 4.3.2.2.1. Driving heads shall be made of toughened, quenched and tempered stainless steel with reference symbol Z; in accordance with BS PD 970:2005 and as recommended by BS 7430:2011.
- 4.3.2.2.2. The steel shall have a tensile strength of 1150 MPa to 1300 MPa and shall be able to withstand hammer blows used while hammering an earth rod into ground.
- 4.3.2.2.3. It shall dimensionally conform to BS 4168-1 (knurled head) and finished standard blue/black.
- 4.3.2.2.4. The threading system shall match with those of the couplings specified in clause 4.2.2 and shall match with the respective coupling sizes.
- 4.3.2.2.5. The diameter of the driving head shall NOT be LESS THAN the diameter of the earth rod/coupler assembly.
- 4.3.2.2.6. The driving head shall be designed to reduce the driving effort on the earth rod and to prevent damage to the copper sheath during the installation process.



**Fig. 4: Driving head**

**4.3.2.3. Earth Rod Clamps**

- 4.3.2.3.1. Earth rod clamps shall be of bull dog-type; its material shall be made of phosphor bronze, grade C102 in accordance with BS 2874, and it shall be suitable for direct burial and compatible with the coupling material.
- 4.3.2.3.2. The surface finish of the completed clamps shall be smooth and free of cracks, burrs and sharp projections. Conformance to no sharp projections shall be tested using a Sharp Edge Tester device calibrated to UL Standard 1439.

Issued by: Head of Section, Technical Standards  
and Specifications

Authorized by: Head of Department, R&D

Signed:



Signed:

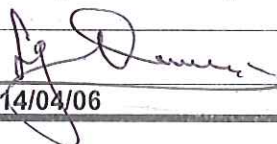

Date: 2014/04/06

Date: 2014/04/06

**SPECIFICATION FOR EARTH RODS AND THEIR CONNECTORS**

Part 1: Copper Clad Earth Rods and their connectors

Doc. No.	KP1/3CB/TSP/06/031-1
Issue No.	3
Revision No.	0
Date of Issue	2014-04-06
Page 11 of 19	

4.3.2.3.3. The clamp in the assembled mode shall exhibit no less than 95% of the conductivity of a solid earth conductor.

4.3.2.3.4. The joined clamp/grounding conductor/rod electrode assembly shall withstand a pullout force of no less than 2.0 kN before separation. This test shall be performed by pulling on the grounding conductor with the rod held firmly in place, the clamp providing a securing function only.

4.3.2.3.5. Earth Rod/Conductor clamp shall satisfy the following requirements:

- a) Be suitable for direct burial in the ground.
- b) Be suitable for connecting the specified rods with one or two stranded copper conductors of the following sizes:
  - Minimum conductor size: 50 mm<sup>2</sup> (19/1.80)
  - Maximum conductor size: 70 mm<sup>2</sup> (19/2.10)
- c) Be of materials which are resistant to corrosion and parts of the connector which are in direct contact with the conductor and earth rod shall be of material which does not cause interface corrosion.

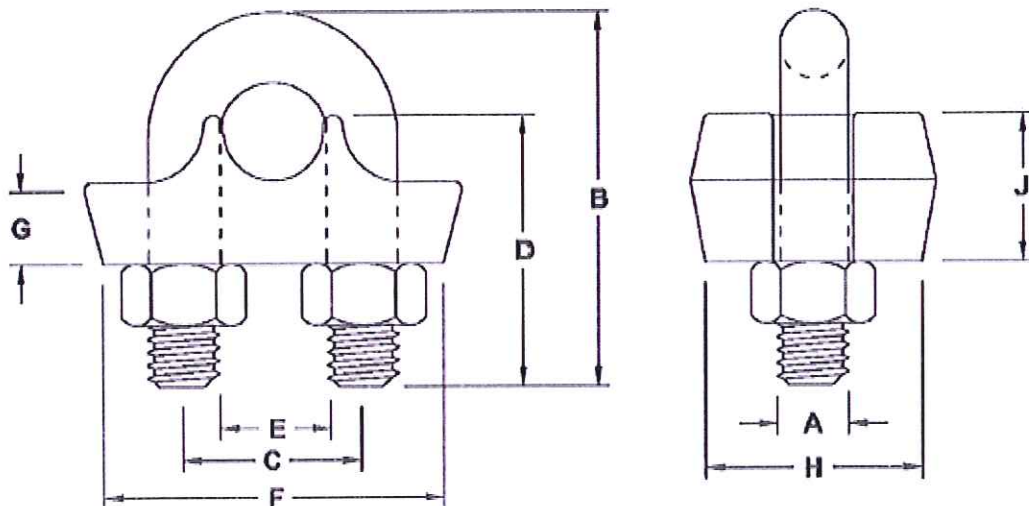

**Fig. 5: Bull Dog type connector.**

Issued by: Head of Section, Technical Standards and Specifications

Signed:



Date: 2014/04/06

Authorized by: Head of Department, R&D

Signed:

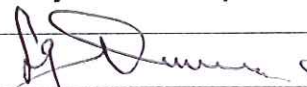

Date: 2014/04/06



**SPECIFICATION FOR EARTH  
RODS AND THEIR  
CONNECTORS**

Part 1: Copper Clad Earth Rods  
and their connectors

Doc. No.	KP1/3CB/TSP/06/031-1
Issue No.	3
Revision No.	0
Date of Issue	2014-04-06
Page 12 of 19	

**Table 5: Recommended dimensions of bull-dog clamp.**

Recommended earth rod size mm	A mm	B mm	C mm	D mm	E mm	F mm	G mm	H mm	J mm
M12.5	Φ12	64	27	32	15	51	12	28	22
M16, M20, M25	Φ14	82	36	36	40	22	64	32	25

4.3.2.3.6. The U-bolt, nut and washers shall be made from phosphor bronze designation CW451K conforming to BS EN 12163:2011 as recommended by BS 7430:2011 and shall be suitable for direct burial and compatible with the coupling material.

4.3.2.3.7. Assembly torque for bull-dog clamps shall be 70 Nm as the screw thread pitch for the bolts shall be as per clause 4.2.2. The tenderer shall advise the minimum and maximum recommended tightening torques as well as the specified tightening technique/procedure.

4.3.2.3.8. Recommended sizes of the bull dog clamp shall be as per Table 5.

**4.4. Sampling for tests**

Test specimens shall be selected at random from each inspection lot (or articles) in accordance with ISO 2859-1. The number of samples selected from each lot shall comply with Table 6 of this specification.

**Table 6: Number of test samples**

Lot size	Sample size	Lot size	Sample size
25 or less	5	501 to 1,200	80
26 to 50	8	1,201 to 3,200	125
51 to 90	13	3,201 to 10,000	200
91 to 150	20	10,000 to 35,000	315
151 to 280	32	35,001 to over	500
281 to 500	50		

**4.5. Quality Management System**

4.5.1. The supplier shall submit a quality assurance plan (QAP) that will be used to ensure that the design, material, workmanship, tests, service capability, maintenance and documentation of the copper-clad earth rod and their connectors, will fulfill the requirements stated in the

Issued by: Head of Section, Technical Standards and Specifications

Authorized by: Head of Department, R&D

Signed:

Signed:

Date: 2014/04/06

Date: 2014/04/06



**SPECIFICATION FOR EARTH RODS AND THEIR CONNECTORS**

Part 1: Copper Clad Earth Rods and their connectors

Doc. No.	KP1/3CB/TSP/06/031-1
Issue No.	3
Revision No.	0
Date of Issue	2014-04-06
Page 13 of 19	

contract documents, standards, specifications and regulations. The QAP shall be based on and include relevant parts to fulfill the requirements of ISO 9001:2008.

4.5.2. The Manufacturer's Declaration of Conformity to applicable standards and copies of quality management certifications including copy of valid and relevant ISO 9001: 2008 certificate shall be submitted with the tender for evaluation.

4.5.3. The bidder shall indicate the delivery time of the copper-clad earth rod and their connectors, manufacturer's monthly & annual production capacity and experience in the production of the type and size of items being offered.

**5.0. TESTS AND INSPECTION**

**5.1. Performance and Testing**

**5.1.1. Couplings**

5.1.1.1. Two 450 mm rod samples shall be coupled and held vertically in a tubular fixture that is at least 0.25 mm greater than the rod diameter.

5.1.1.2. The penetrating end of the bottom ground rod shall be rested on a fixed plate of a weight sufficient to withstand the impact test, and located in a hole at least 100 mm in depth.

5.1.1.3. The coupling shall not rest on or be contained within the tubular fixture or fixture plate. The top ground rod shall be subjected to an impact force of 55 Nm. After 25 impacts, the couplings shall not break, split, or be subjected to damage that impairs performance.

5.1.1.4. The joined coupling/rod assembly shall be able to withstand a pullout force of no less than 6.5 KN before separation.

**5.1.2. Earth rod clamp**

5.1.2.1. The clamps shall be installed in accordance with the manufacturer's instructions. The complete test procedure shall be as given below:

- a) The earth rod/connector/conductor combination shall be tested in still air. The locations of the connections for injecting the test current shall be positioned not less than twenty (20) times the diameter of the earth rod from the centre of the connector for all tests.

Issued by: Head of Section, Technical Standards and Specifications

Authorized by: Head of Department, R&D

Signed:

Signed:

Date: 2014/04/06

Date: 2014/04/06



**SPECIFICATION FOR EARTH RODS AND THEIR CONNECTORS**

Part 1: Copper Clad Earth Rods and their connectors

Doc. No.	KP1/3CB/TSP/06/031-1
Issue No.	3
Revision No.	0
Date of Issue	2014-04-06
Page 14 of 19	

- b) Tests shall be carried out on the following connection combinations for the connectors as detailed below:
  - 50 mm<sup>2</sup> conductor to earth rod,
  - 70 mm<sup>2</sup> conductor to earth rod,
  - 50mm<sup>2</sup> conductor to 50 mm<sup>2</sup> conductor,
  - 50 mm<sup>2</sup> conductor to 70 mm<sup>2</sup> conductor,
  - 50 mm<sup>2</sup> cable conductor to 50 mm<sup>2</sup> cable conductor,
  - 50 mm<sup>2</sup> cable conductor to 70 mm<sup>2</sup> cable conductor ,
  - 70 mm<sup>2</sup> cable conductor to 70 mm<sup>2</sup> cable conductor.
- c) A minimum average test current of 5 kA, 50 Hz for 1 second (I<sup>2</sup>t of 25 MA<sup>2</sup>/second) shall be used for each test.
- d) Visual inspection after the test shall ensure that there is no damage to the connector and there is no severe discolouration to the connector and surrounding areas. There should be no loosening of the connection between the cable and the rod or between the cable and the cable.

5.1.2.2. The successful tenderer shall provide test reports that verify the requirements detailed above before the first deliveries are accepted under the contract.

**5.2.** The copper-clad earth rod and their connectors shall be inspected and tested in accordance with the requirements of BS PD 970, BS 2874, BS EN 12163, BS 3643-2 and KS 04-744 standards and provisions of this specification. It shall be the responsibility of the supplier to perform or to have performed the tests specified and whatever other tests he normally performs at works.

**5.3.** Copies of previous Type Tests Reports issued by a third party testing laboratory that is accredited to ISO/IEC 17025 shall be submitted with the tender for the purpose of technical evaluation. The accreditation certificate to ISO/IEC 17025 for the same third party testing laboratory used shall also be submitted with the tender document (all in English Language)

**5.4.** Copies of type test reports to be submitted with the tender (by bidder) for evaluation for the copper-clad earth rod and their connectors shall be as stated below:

- a) Adherence of copper clad to steel core
- b) Current carrying capacity tests
- c) Mechanical Strength – ultimate tensile strength tests
- d) Chemical composition – Check Analysis
- e) Hardness Test

Issued by: Head of Section, Technical Standards and Specifications

Authorized by: Head of Department, R&D

Signed:

Signed:

Date: 2014/04/06

Date: 2014/04/06



## SPECIFICATION FOR EARTH RODS AND THEIR CONNECTORS

Part 1: Copper Clad Earth Rods and their connectors

Doc. No.	KP1/3CB/TSP/06/031-1
Issue No.	3
Revision No.	0
Date of Issue	2014-04-06
Page 15 of 19	

f) Impact Test

**5.5.** Routine and sample test reports for the copper-clad earth rod and their connectors to be supplied shall be submitted to KPLC for approval before shipment/delivery of the goods. KPLC Engineers will witness tests at the factory before shipment.

**5.6.** Tests to be witnessed by KPLC Engineers at the factory before shipment shall be in accordance with of BS PD 970, BS 2874, BS EN 12163, BS 3643-2 and KS 04-744 standards and provisions of this specification and shall include the following:

- a) Verification of dimensions
- b) Adherence of copper clad to steel core
- c) Current carrying capacity tests
- d) Mechanical strength – ultimate tensile strength tests
- e) Checking the condition of the threads (earth rod, coupling, driving head and bull dog clamp U-bolt and nut) and copper cladding after performing a driving (in to hard soil) operation.
- f) Bending test

**5.7.** On receipt of the goods KPLC may perform any of the tests specified in order to verify compliance with this specification. The supplier shall replace without charge to KPLC the copper-clad earth rod and their connectors, which upon examination, test or use; fail to meet any of the requirements in the specification.

### 6.0. MARKING AND PACKING

#### 6.1. Marking

6.1.1. Each copper-clad earth rod shall be indelibly marked with the following information (in English Language):

- Name or trade mark of the manufacturer
- The length of the rod in meters or millimetres,
- The diameter of the rod in millimetres,
- Any information which the manufacturer considers necessary for the correct installation service.
- Letters "KPLC"

6.1.2. Couplings and connectors shall be marked with :

- Name or trade mark of the manufacturer
- Trade size

Issued by: Head of Section, Technical Standards and Specifications

Signed:

Date: 2014/04/06

Authorized by: Head of Department, R&D

Signed:

Date: 2014/04/06



## SPECIFICATION FOR EARTH RODS AND THEIR CONNECTORS

Part 1: Copper Clad Earth Rods and their connectors

Doc. No.	KP1/3CB/TSP/06/031-1
Issue No.	3
Revision No.	0
Date of Issue	2014-04-06
Page 16 of 19	

- Letters "KPLC"

6.1.3. The driving head shall be marked as per the requirements of BS 4168-1.

### 6.2. PACKING

6.2.1. The copper clad earth rods, couplings, connectors and driving heads shall be suitably packed separately in reinforced wooden boxes firmly secured with metallic straps and the quantity of items in a package is as in a), b), c), or d) given below.

- a) Copper Clad Earth Rods - 50 per box
- b) Couplings - 100 per box
- c) Connectors - 100 per box
- d) Driving Heads - 100 per box

6.2.2. Each Packing shall be clearly and indelibly marked with the following;

- a) Name of Item
- b) Quantity
- c) Gross Weight
- d) The boxes shall be marked with manufacturer's identification and property class and the words "PROPERTY OF KPLC".

### 7. DOCUMENTATION

7.1 The bidder shall submit its tender complete with technical documents required by Annex A (Guaranteed Technical Particulars) for tender evaluation. The technical documents to be submitted (all in English language) for tender evaluation shall include the following:

- a) Fully filled clause by clause description of the item on offer as per Annex A (Guaranteed Technical Particulars) and signed by the manufacturer;
- b) Copies of the Manufacturer's catalogues, brochures, drawings and technical data which shall include:
  - Model/Reference number, Code Name,
  - Current carrying capacity and the % of current through the coupling.
  - Constructional features and material used for components, the standards to which the items are manufactured and relevant technical literature.
- c) Sales records for the last five years and at least four customer reference letters;
- d) Details of manufacturing capacity and the manufacturer's experience;
- e) Copies of required type test reports by a third party testing laboratory accredited to ISO/IEC 17025;
- f) Copy of accreditation certificate to ISO/IEC 17025 for the third party testing laboratory;

Issued by: Head of Section, Technical Standards and Specifications

Signed:

Date: 2014/04/06

Authorized by: Head of Department, R&D

Signed:

Date: 2014/04/06





**SPECIFICATION FOR EARTH  
RODS AND THEIR  
CONNECTORS**

Part 1: Copper Clad Earth Rods  
and their connectors

Doc. No.	KP1/3CB/TSP/06/031-1
Issue No.	3
Revision No.	0
Date of Issue	2014-04-06
Page 17 of 19	

g) Manufacturers letter of authorization, ISO 9001:2008 certificate and other technical documents required in the tender.

7.2 The successful bidder (supplier) shall submit the following documents/details to The Kenya Power & Lighting Company for approval before manufacture:

- a) Guaranteed Technical Particulars signed by the manufacturer;
- b) Design Drawings with details of copper-clad earth rod and their connectors to be manufactured for KPLC.
- c) Quality assurance plan (QAP) that will be used to ensure that the design, material; workmanship, tests, service capability, maintenance and documentation will fulfill the requirements stated in the contract documents, standards, specifications and regulations. The QAP shall be based on and include relevant parts to fulfill the requirements of ISO 9001:2008
- d) Detailed test program to be used during factory testing;
- e) Marking details and method to be used in marking of the copper-clad earth rod and their;
- f) Manufacturer's undertaking to ensure adequacy of the design, good engineering practice, adherence to the specification and applicable standards and regulations as well as ensuring good workmanship in the manufacture of the copper-clad earth rod and their connectors for The Kenya Power & Lighting Company;
- g) Packaging details (including packaging materials).

7.3 The supplier shall submit recommendations for use, care, storage and routine inspection/testing procedures, all in the English Language, during delivery of the copper-clad earth rod and their connectors to KPLC stores.

-----SPACE LEFT BLANK-----

Issued by: Head of Section, Technical Standards  
and Specifications

Authorized by: Head of Department, R&D

Signed:

Signed:

Date: 2014/04/06

Date: 2014/04/06



**SPECIFICATION FOR EARTH  
RODS AND THEIR  
CONNECTORS**

Part 1: Copper Clad Earth Rods  
and their connectors

Doc. No.	KP1/3CB/TSP/06/031-1
Issue No.	3
Revision No.	0
Date of Issue	2014-04-06
Page 18 of 19	

**ANNEX A: Guaranteed Technical Particulars** (to be filled and signed by the Manufacturer and submitted together with relevant copies of the Manufacturer's catalogues, brochures, drawings, technical data, sales records, four customer reference letters, details of manufacturing capacity, the manufacturer's experience and copies of complete type test reports for tender evaluation, all in English Language)

**Tender No.** .....

Clause number	Bidder's offer (indicate full details of the values offered)
Manufacturer's Name and address	
Country of Manufacture	
Bidder's Name and address	
1. Scope	
1.1-1.4	
2. Applicable Standards	
3. Terms & Definitions	
4. Requirements	
4.1 Service conditions	
4.1.1 – 4.1.2	
4.2 Design and construction	
4.2.1 General	
4.2.1.1 – 4.2.1.3	
Self-tightening	
Improved electrical connections	
No damage to the copper sheath on installation	
4.2.1.4 – 4.2.1.5	
4.2.2 Threading	
4.2.2.1 – 4.2.2.3	
System of threading	
• Earth rods	
• Coupling	
• Connectors	
• Bolts and nuts	
4.3 Specific requirements	
4.3.1 Copper clad earth rods	
4.3.1.1 – 4.3.1.6	
• Taper lengths	
• Earth rod sizes	

Issued by: Head of Section, Technical Standards and Specifications	Authorized by: Head of Department, R&D
Signed:	Signed:
Date: 2014/04/06	Date: 2014/04/06



**SPECIFICATION FOR EARTH RODS AND THEIR CONNECTORS**

Part 1: Copper Clad Earth Rods and their connectors

Doc. No.	KP1/3CB/TSP/06/031-1
Issue No.	3
Revision No.	0
Date of Issue	2014-04-06
Page 19 of 19	

Clause number	Bidder's offer (indicate full details of the values offered)
4.3.2 Connectors	
4.3.2.1 Couplings	
4.3.2.1.1 – 4.3.2.1.6	
• Coupling sizes	
4.3.2.2 Driving Head	
4.3.2.2.1 - 4.3.2.2.6	
4.3.2.3 Earth rod clamps	
4.3.2.3.1 – 4.3.2.3.8	
4.4 Sampling	
4.5 Quality Management Systems	
4.5.1 – 4.5.3	
5.0 Tests and Inspection	
5.1 Performance and testing	
5.1.1 Couplings	
5.1.1.1 – 5.1.1.4	
5.1.2 Connectors	
5.1.2.1 – 5.1.2.2	
5.2 – 5.7 Routine and type tests	
6. Marking & Packaging	
6.1. Marking	
6.2 Packaging	
6.2.1 – 6.2.3	
7. Documentation	
7.1 – 7.3	
8.0	Manufacturer's Guarantee and Warranty
9.0	List catalogues, brochures, technical data and drawings submitted to support the offer.
10.0	List customer sales records and customer reference letters submitted to support the offer.
11.0	List Test Reports submitted with tender
12.0	List test & calibration reports to be submitted to KPLC for approval before shipment
13.0	Statement of compliance to specification (indicate deviations if any & supporting documents)

.....  
**Manufacturer's Name, Signature, Stamp and Date**

Issued by: Head of Section, Technical Standards and Specifications

Authorized by: Head of Department, R&D

Signed:

Signed:

Date: 2014/04/06

Date: 2014/04/06

